

**AUSTRIA | MOLTO LUCE GMBH**

HEADQUARTERS WELS  
Office & Showroom  
Europastraße 45  
4600 Wels  
T: +43 7242 698-0  
M: office@moltoluce.com

VIENNA  
Office & Showroom  
Vorarlberger Allee 28  
1230 Vienna  
T: +43 1 6160300  
M: office.wien@moltoluce.com

GRAZ  
Office  
Robert-Viertl-Straße 2  
8055 Graz  
T: +43 316 672525-0  
M: office.graz@moltoluce.com

INNSBRUCK  
Office  
Orbis Office, Resselstraße 33 / Top 5  
6020 Innsbruck  
T: +43 512 345688  
M: office.innsbruck@moltoluce.com

**GERMANY | MOLTO LUCE GMBH**

MUNICH  
Office & Showroom  
Walter-Gropius-Straße 23  
80807 Munich  
T: +49 89 4520565-0  
M: office.muenchen@moltoluce.com

COLOGNE  
Office & Showroom  
Gut Maarhausen, Eiler Straße 3v  
51107 Cologne  
T: +49 221 222882-0  
M: office.koeln@moltoluce.com

HAMBURG  
Office & Showroom  
Wandsbeker Allee 77  
22041 Hamburg  
T: +49 40 2847850-1  
M: office.hamburg@moltoluce.com

**ITALY | MOLTO LUCE srl**

BRESCIA  
Office  
Viale Duca D' Aosta 28  
25121 Brescia  
T: +39 030 2400679  
M: office.brescia@moltoluce.com

**SWITZERLAND | MOLTO LUCE AG**

LENZBURG  
Office  
Niederlenzerstraße 25  
5600 Lenzburg  
T: +41 62 885 70 30  
M: office.lenzburg@moltoluce.com

www.moltoluce.com

MOLTO LUCE®

# VOLARE TRACK

20 / 21



V\_1\_000

MOLTO LUCE®

## VOLARE EINBAUPROFIL & ZUBEHÖR / VOLARE RECESSED PROFILE & ACCESSORIES

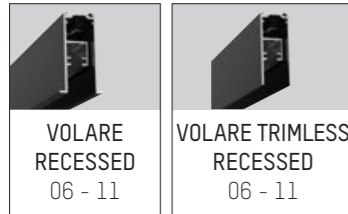

VOLARE  
RECESSED  
06 - 11

VOLARE TRIMLESS  
RECESSED  
06 - 11

## VOLARE SCHIENENSYSTEM & ZUBEHÖR / VOLARE TRACK SYSTEM & ACCESSORIES



VOLARE  
SYSTEM TRACK  
14 - 17

## VOLARE STRAHLER UND LEUCHTEN / VOLARE SPOTS & LUMINAIRES

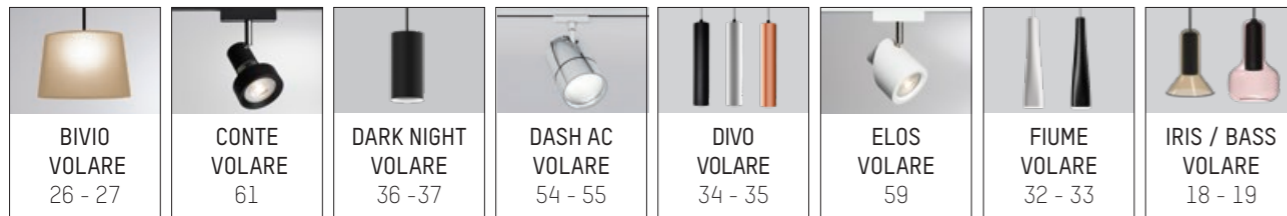

BIVIO  
VOLARE  
26 - 27

CONTE  
VOLARE  
61

DARK NIGHT  
VOLARE  
36 - 37

DASH AC  
VOLARE  
54 - 55

DIVO  
VOLARE  
34 - 35

ELOS  
VOLARE  
59

FIUME  
VOLARE  
32 - 33

IRIS / BASS  
VOLARE  
18 - 19



LEO  
VOLARE  
28 - 29

LITIN  
VOLARE  
56

LOON MINI  
BALL VOLARE  
20 - 21

MIX  
VOLARE  
57

MOVA S  
VOLARE  
44 - 47

MOVA S LONG  
VOLARE  
48 - 51

MOVA S GU10  
VOLARE  
52 - 53

PEYA  
VOLARE  
30 - 31



SENSO  
VOLARE  
60

SHOOTER  
VOLARE  
58

TRIGGA LOON  
MINI VOLARE  
22 - 23

TRIGGA SPOT  
VOLARE  
40 - 41

TRIGGA  
VOLARE  
38 - 39

V-LINE  
VOLARE  
62 - 63

VIBIO  
VOLARE  
42 - 43

YAJO  
VOLARE  
24 - 25

## FARBEN & ZEICHENERKLÄRUNG / COLOURS & PICTOGRAM LEGEND

W	weiß	white	bianco	blanc
WO	weiß opal	white opal	bianco opale	blanc opal
G	grau	grey	grigio	gris
RG	rauchgrau	smoky grey	fumo grigio	fumée gris
A	anthrazit	anthracite	antracite	anthracite
S	silber	silver	argento	argent
SM	silber matt	silver matt	argento opaco	argent mat
SB	silber geschliffen	silver grinded	argento molato	argent meulé
AE	aluminium eloxiert	aluminium anodized	alluminio anodizzato	aluminium anodisé
C	chrom	chrome	cromo	chrome
PC	perlchrom	pearl chrome	cromo satinato	chrome satiné
BE	bronze eloxiert	bronze anodized	bronzo anodizzato	bronze anodisé
S	schwarz	black	nero	noir
AM	amber	amber	ambra	amber
CH	champagner	champagne	champagne	champagne
P	pink	pink	rose fucsia	rose fuchsia
BE	beige	beige	beige	beige
B	braun	brown	marrone	marron
DB	dunkelbraun	dark brown	marrone scuro	marron foncé
G	gold	gold	oro	or
RG	rosegold	rosegold	rosa oro	rosa or
KU	kupfer	copper	ramato	cuivre

W2	LED 2700K	LED 2700K	LED 2700K	LED 2700K
W3	LED 3000K	LED 3000K	LED 3000K	LED 3000K
W4	LED 4000K	LED 4000K	LED 4000K	LED 4000K
S	schaltbar	switchable	commutabile	commutable
Z	ZigBee dimm	ZigBee dimm	ZigBee dimm	ZigBee dimm
L	LOXONE AIR dimm	<b>LOXONE Ready</b> LOXONE AIR dimm	LOXONE AIR dimm	LOXONE AIR dimm
20°	Ausstrahlwinkel	Beam angle	Angolo di radiazione	Angle de rayonnement
↻	dreh- und schwenkbar	twistable and pivoting	orientabile e girevole	orientable et pivotant
↻	drehbar	twistable	girevole	pivotant
↻	schwenkbar	pivoting	orientabile	orientable

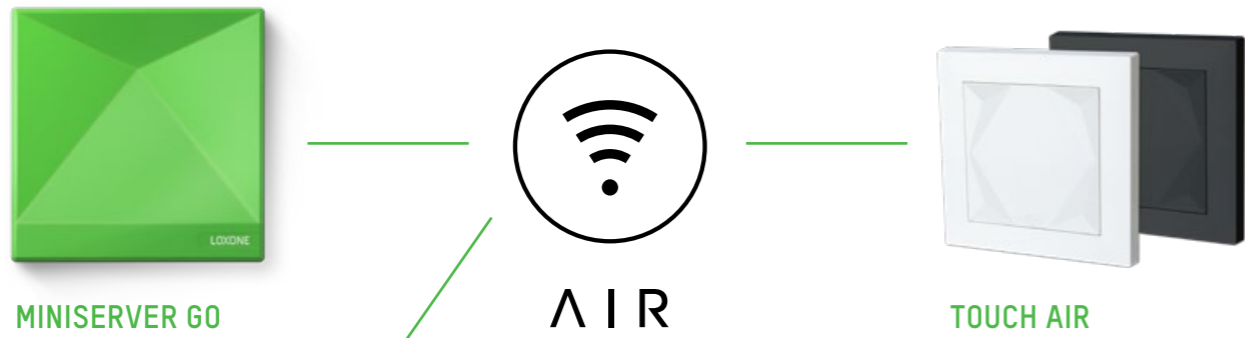

MINISERVER GO

AIR

TOUCH AIR

LOXONE Ready



AIR SCHNITTSTELLE FÜR STANDARDTASTER

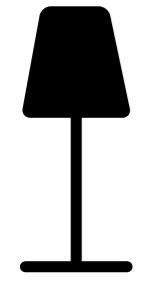

AIR INTERFACE FOR STANDARD PUSH-BUTTON



AIR BEWEGUNGSMELDER AIR MOTION DETECTOR

## LOXONE AIR TECHNOLOGIE / LOXONE AIR TECHNOLOGY

Im Gegensatz zu anderen Funktechnologien wurde LOXONE Air eigens für das intelligente Gebäude entwickelt und bringt somit einzigartige Features mit.

In opposite to other radio technologies, LOXONE Air was specially developed for the intelligent building and that brings unique features.

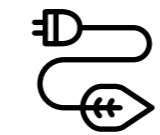

MINIMALER VERBRAUCH  
MINIMAL CONSUMPTION

Alle Loxone Air Produkte sind Energieverbrauchs-optimiert. Eigens entwickelte Chips sorgen für niedrigsten Verbrauch.

All Loxone Air devices are designed with energy conservation in mind. The device chip set and the pertaining software ensure low energy consumption.



100% AUF LOXONE ABGESTIMMT  
100% TUNED FOR LOXONE

Die AIR Technologie und alle AIR Produkte werden per Plug & Play in Betrieb genommen und arbeiten perfekt mit allen Loxone Komponenten zusammen.

The AIR technology and all AIR devices have been designed to seamlessly work together and deliver exceptional functionality compared to stand alone solutions.

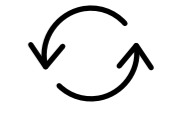

UPDATEFÄHIG  
FUTURE-READY

Alle Loxone Air Produkte sind voll updatefähig. Ihr Projekt bleibt also zukunftsfähig.

All Loxone Air devices can receive free software updates. Your Project is already fit for future.



MESH TECHNOLOGIE  
MESH TECHNOLOGY

Jedes Produkt das an einer dauerhaften Spannungsversorgung angeschlossen ist, erhöht die Reichweite.

Any product that is permanently connected to mains power can increase the range.



VERSCHLÜSSELUNG  
FULLY-ENCRYPTED COMMUNICATION

Die Kommunikation zwischen AIR Produkten ist mittels IPSec, dem aktuellen Sicherheitsstandard gesichert.

The communication between AIR devices is using IPSec, the current industry standard for secure.

## JEDEN WINKEL ERREICHEN – DANK MESH TECHNOLOGIE A RELIABLE WIRELESS SOLUTION – THANKS TO MESH TECHNOLOGY

Loxone Air basiert auf der bidirektionalen Mesh-Technologie. Jedes fix am Strom angeschlossene Air Gerät erweitert die Reichweite und Stabilität des Gesamtsystems. Die Konsequenz: Unglaubliche Reichweiten, Dicke Wände, große Entfernungen. Dadurch erreichen sie jeden Winkel Ihres Heims und erhalten ein super stabiles Netz.

Loxone Air is based on bidirectional mesh technology. Each Loxone Air device that is permanently powered is helping to extend the footprint of the wireless signal. The result is a reliable and well-supported Loxone Air range. While it isn't possible to take all installation environments into account, the technology behind Loxone Air will certainly provide an ideal solution for wireless automation.

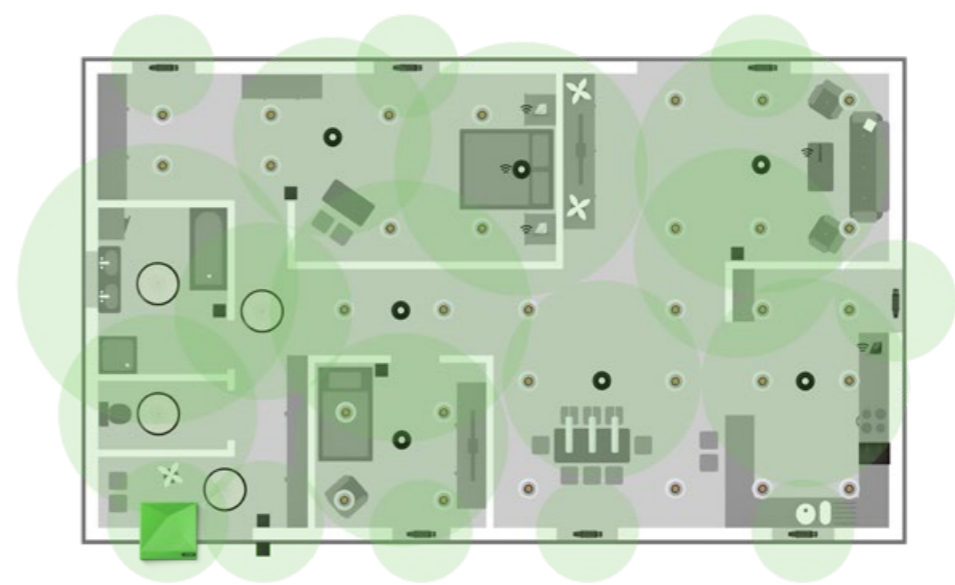



# VOLARE R TRIMLESS

Design: Doc Form

# VOLARE R & VOLARE TRIMLESS R

230V HARDLY VISIBLE IN THE CEILING

Volare R - Eine gelungene Erweiterung für unser Volare Stromschienensystem. Die minimalistische 230V 2-Phasen Schiene mit 18x18mm kann nun mittels einem Einbauprofil in die Decke eingebaut werden. Mit einer Breite von 32mm ist die Variante mit Rahmen kaum sichtbar in der Decke. Um das System perfekt abzurunden, gibt es zusätzlich eine nur 24mm breite rahmenlose Variante zur Auswahl, welche den Minimalismus nochmals unterstreicht. Durch die Bauform des Profils verschwinden die magnetisch gehaltene Volare-Schiene und der Adapter der Leuchte zur Gänze in der Decke und können auf einfache Weise mit einem Demontagewerkzeug wieder demontiert werden. Erhältlich ist das System in den Farben schwarz und weiß.

Volare R - a successful extension for our Volare power rail system. The minimalist 230 V 2-stage rail, size 18 x 18 mm, can now be integrated into the ceiling using a recessed profile. At a width of 32 mm, the version with a frame is barely visible in the ceiling. To finish off the system perfectly, there is also a frameless version of only 24 mm available, which also emphasises the minimalist design. Thanks to the shape of the section, the magnetically attached Volare rails and lighting adaptor completely disappear into the ceiling and can easily be dismantled with a dismantling tool. The system is available in black and white.

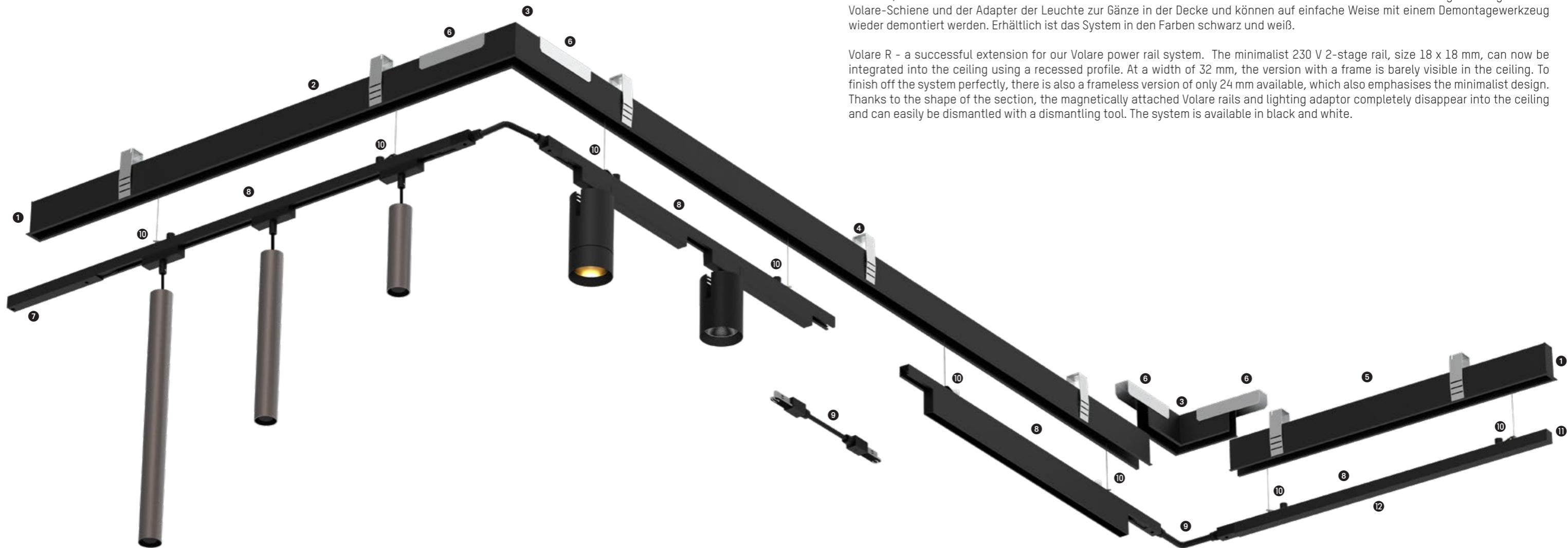

## VOLARE R & VOLARE TRIMLESS R MOUNTING OPTIONS

- ❶ Enddeckel Einbauprofil / End cap recessed profile
- ❷ Einbauprofil 1205 / Recessed profile 1205
- ❸ 90° Winkelprofil / 90° Junction
- ❹ Einbauprofil 2205 / Recessed profile 2205
- ❺ Einbauprofil 1005 / Recessed profile 1005
- ❻ Verbinder / junction
- ❼ Endeinspeisung / End power feed
- ❽ Volare Stromschiene / Volare Track
- ❾ Flex-Verbinder / Flexible-junction
- ❿ Magnet-Set + Sicherung / Magnet-Set + protection
- ⓫ Enddeckel Volare Profil / End cap Volare profile
- ⓬ Blindabdeckung / Aluminium cover

## DC ADAPTER BÜNDIG MIT SCHIENE | ADAPTER FLUSH WITH RAIL

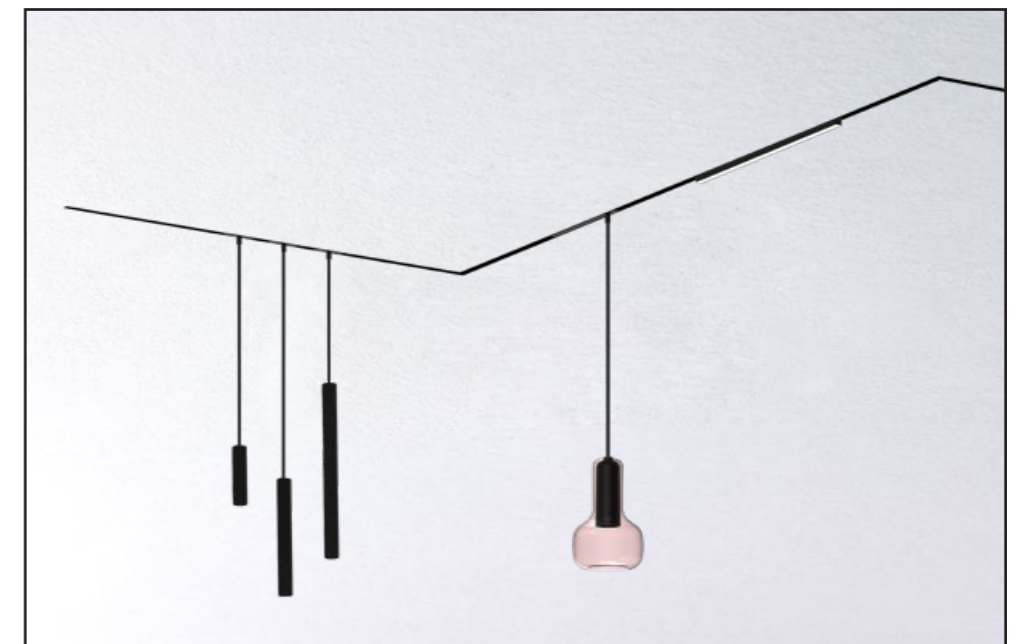

## VOLARE R PROFILE SET

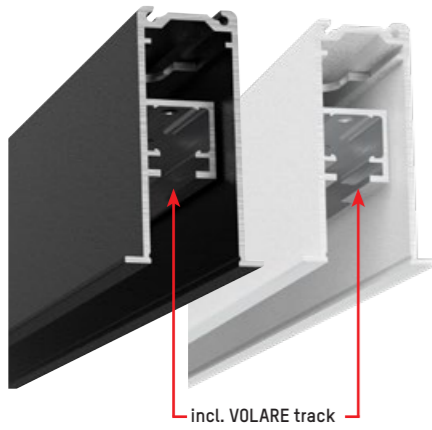

incl. VOLARE track

Einbaukanal aus Aluminiumprofil  
Oberfläche weiß oder schwarz

Recessed profile made of aluminium  
Surface, white or black

Profilo ad incasso in alluminio  
Finitura in bianco o nero

Profil en aluminium encastré  
Finition noir ou blanc

IP20

## VOLARE R PROFILSET / VOLARE R PROFILE SET

Profil-Set bestehend aus Einbaukanal, Volare Schiene & Befestigungszubehör.  
Exkl. Einspeiser, elektrischen und mechanischen Verbinder  
Profile-set consisting of installation channel, Volare track & mounting accessories.  
Excl. power feed, electrical and mechanical connector

652-0140100005 L: 1205mm    652-0140100006 L: 1205mm  
652-0140200005 L: 2205mm    652-0140200006 L: 2205mm

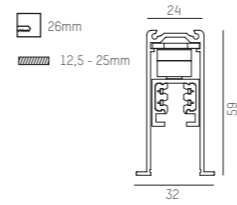

## VOLARE R ENDPROFILSET / VOLARE R END PROFILE SET

Profil-Set für die Verwendung nach einem 90° Verbinder bestehend aus Einbaukanal, Volare Schiene & Befestigungszubehör. Exkl. elektrischen und mechanischen Verbinder  
Profile-set for mounting after a 90° connector consisting of installation channel, Volare track & mounting accessories. Excl. electrical and mechanical connector

652-0150100005 L: 1020mm    652-0150100006 L: 1020mm  
652-0150200005 L: 2020mm    652-0150200006 L: 2020mm

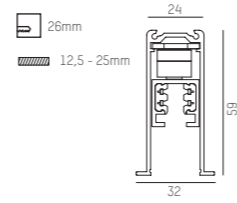

## VOLARE R ENDKAPPE / VOLARE R END CAP

652-0090100005   
652-0090100006

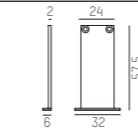

## VOLARE R 90° WINKELPROFIL / VOLARE R 90° PROFILE

652-0030900005   
652-0030900006

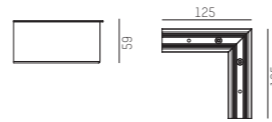

## VOLARE R VERBINDER / VOLARE R JUNCTION

652-00308

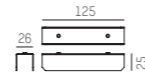

## VOLARE TRIMLESS R PROFILE SET

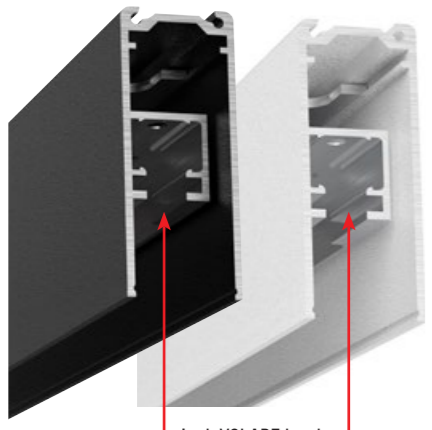

incl. VOLARE track

Rahmenloser Einbaukanal aus Aluminiumprofil  
Oberfläche weiß oder schwarz

2-phase rail made of aluminium  
Surface, white or black

Profilo frameless in alluminio, ad incasso totale  
Finitura in bianco o nero

Profil sans cadre en aluminium encastré  
Finition noir ou blanc

IP20

## VOLARE TRIMLESS PROFILSET R / VOLARE TRIMLESS R PROFILE SET

Profil-Set bestehend aus Einbaukanal, Volare Schiene & Befestigungszubehör.  
Exkl. Einspeiser, elektrischen und mechanischen Verbinder  
Profile-set consisting of installation channel, Volare track & mounting accessories.  
Excl. power feed, electrical and mechanical connector

652-0170100005 L: 1205mm    652-0170100006 L: 1205mm  
652-0170200005 L: 2205mm    652-0170200006 L: 2205mm

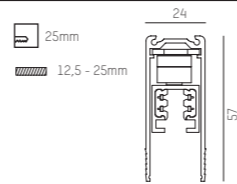

## VOLARE TRIMLESS R ENDPROFILSET / VOLARE TRIMLESS R END PROFILE SET

Profil-Set für die Verwendung nach einem 90° Verbinder bestehend aus Einbaukanal, Volare Schiene & Befestigungszubehör. Exkl. elektrischen und mechanischen Verbinder  
Profile-set for mounting after a 90° connector consisting of installation channel, Volare track & mounting accessories. Excl. electrical and mechanical connector

652-0180100005 L: 1020mm    652-0180100006 L: 1020mm  
652-0180200005 L: 2020mm    652-0180200006 L: 2020mm

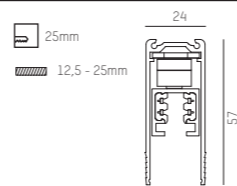

## VOLARE TRIMLESS R ENDKAPPE / VOLARE TRIMLESS R END CAP

652-0090200005   
652-0090200006

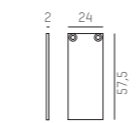

## VOLARE TRIMLESS R 90° WINKELPROFIL / VOLARE TRIMLESS R 90° PROFILE

652-0031000005   
652-0031000006

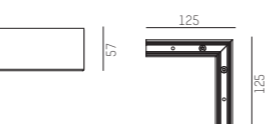

## VOLARE TRIMLESS R VERBINDER / VOLARE TRIMLESS R JUNCTION

652-00308

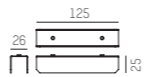

## ACCESSORIES

### ENDKAPPE FÜR VOLARE SCHIENE / END CAP FOR VOLARE TRACK

Alle Stromschienen müssen mit einer Endkappe versehen werden!  
All track endings have to be equipped with endpieces!

652-0050200005   
652-0050200006

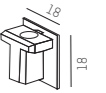

### BLINDABDECKUNG / ALUMINIUM COVER

Für 2-Phasen Schiene, inkl. 6 Stk. Halteclips / for 2-phase track incl. 6 pcs. holding clips

652-0050100005 L: 1000mm  
652-0050100006 L: 1000mm

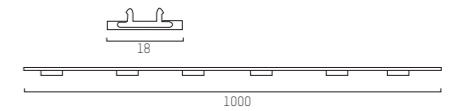

### ENDEINSPEISUNG / END POWER FEED

652-0040100005   
652-0040100006

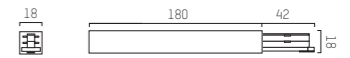

### FLEXVERBINDER / FLEXIBLE JUNCTION

652-0030700005   
652-0030700006

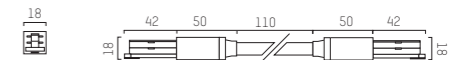

### MONTAGEWERKZEUG FÜR DIE EINBAUBÜGEL BEI VOLARE R TRIMLESS / INSTALLATION TOOL FOR MOUNTING BRACKETS FOR VOLARE R TRIMLESS

1 Stück pro System notwendig / 1 piece per system needed

652-00003

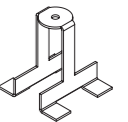

### DEMONTAGEWERKZEUG FÜR VOLARE STROMSCHIENE / REMOVAL TOOL FOR VOLARE TRACK

652-00002



### DEMONTAGEWERKZEUG / REMOVAL TOOL

Für Volare DC, und V-Line Leuchten / for Volare DC and V-Line luminaires

652-0000100000

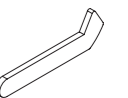

# VOLARE



## THE SMALLEST 2-PHASE TRACK SYSTEM IN THE WORLD

Die Alternative für Menschen, die das Zarte und das Besondere suchen. Minimalismus und Purismus werden in einer 230V 2-Phasen Schiene mit 18x18mm vereint. Volare ist weltweit das kleinste 2-Phasen-Stromschienensystem. Einfachste Montage der Schienen direkt an Wand oder Decke durch vorgebohrte Löcher oder als abgehängte Versionen mittels Seil oder Stangen. Der Adapter besteht nicht nur durch seine kompakte Bauform, sondern ist auch völlig unkompliziert in der Schiene zu fixieren.

The alternative for those who are looking for something delicate and special. Minimalism and purism are united in a 230V two-phase 18x18mm rail. Volare is currently the smallest two-phase power rail system worldwide. Pre-drilled holes make rails extremely simple to fit to walls and ceilings or as pendant versions with cables and rods. The adapter is not only impressively small but is also extremely simple to fit into the rail.



Montage des VOLARE Adapters (Video)  
Mounting of VOLARE adapter (Video)



2-Phasen Stromschiene aus Aluminiumprofil  
Oberfläche eloxiert, weiß, schwarz oder chrom  
Installation als Aufbau- und Pendelmontage  
Systemzubehör separat ordern

2-phase rail made of aluminium  
Anodised surface, white powder coated or chrome  
Surface or suspended mount  
Order accessories separately

Binario bifase in alluminio  
Anodizzato, verniciatura a polveri bianca o in cromo  
Montaggio a soffitto/parete o sospensione  
Ordinare gli accessori separatamente

Rail à 2 phases en aluminium  
Anodisé, vernissage à poudres en blanc ou noir  
Montage à plafon/paroi ou suspension  
Commander les accessoires séparément

IP 20

### 2-PHASEN STROMSCHIENE / 2-PHASE CIRCUIT TRACK

2 - Phasenschiene mit Bohrungen; 230V; max. Belastung: 10A pro Phase; beliebig kürzbar  
2 - phase circuit track incl. holes; 230V max. load: 10A per phase; cut to any length

652-0010100001 L: 1000mm  
652-0010200001 L: 2000mm

652-0010100008 L: 1000mm  
652-0010200008 L: 2000mm  
652-0010300008 L: 2950mm

652-0010100005 L: 1000mm  
652-0010200005 L: 2000mm  
652-0010300005 L: 2950mm

652-0010100006 L: 1000mm  
652-0010200006 L: 2000mm  
652-0010300006 L: 2950mm

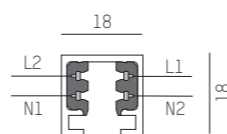

### ENDKAPPE / END PIECE

Alle Stromschienen müssen mit einer Endkappe versehen werden!  
All track endings have to be equipped with endpieces!

652-0050200004   
652-0050200008   
652-0050200005   
652-0050200006



### DECKENBEFESTIGUNG / SURFACE MOUNTING

652-0020100001 H: 15mm  
652-0020100008 H: 15mm  
652-0020100005 H: 15mm  
652-0020100006 H: 15mm

652-0020200001 H: 71mm  
652-0020200008 H: 71mm  
652-0020200005 H: 71mm  
652-0020200006 H: 71mm

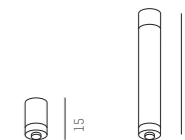

### SEILABHÄNGUNG / STEEL CABLE SUSPENSION

beliebig kürzbar  
cut to any length

652-0020300001 L: 1000mm  
652-0020300008 L: 1000mm  
652-0020300005 L: 1000mm  
652-0020300006 L: 1000mm

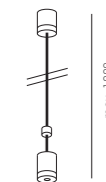

### JUNCTION

#### LINEARVERBINDER / LINEAR JUNCTION

L: 70mm; 4 x 1,5mm<sup>2</sup>

652-0030100001

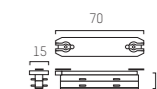

#### ISOLIERVERBINDER / INSULATING JUNCTION

L: 70mm; 4 x 1,5mm<sup>2</sup>

652-0030200001

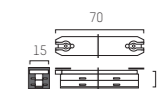

#### FLEXIBLER WINKELVERBINDER / FLEXIBLE JUNCTION

L: 110mm; 4 x 1,5mm<sup>2</sup>

652-0030300001

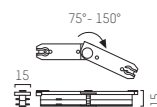

#### 90° WINKELVERBINDER / 90° JUNCTION

L: 25mm; 4 x 1,5mm<sup>2</sup>

652-0030400001

652-0030400008

652-0030400005

652-0030400006

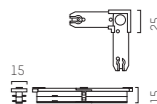

#### T-VERBINDER / T-JUNCTION

L: 130 x B: 65mm; 4 x 1,5mm<sup>2</sup>

652-0030500001

652-0030500008

652-0030500005

652-0030500006

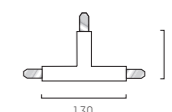

#### KREUZVERBINDER / X-JUNCTION

L: 130 x B: 130mm; 4 x 1,5mm<sup>2</sup>

652-0030600001

652-0030600008

652-0030600005

652-0030600006

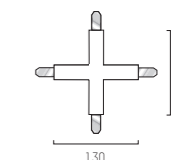

### ACCESSORIES

#### DEMONTAGWERKZEUG / REMOVAL TOOL

Für Volare DC und V-Line Leuchten / for Volare DC and V-Line luminaires

652-0000100000

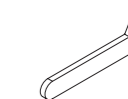



## POWER FEED

### ENDEINSPEISUNG / END POWER FEED

ACHTUNG: Installationsschlauch max. Ø 16mm verwenden / ATTENTION: Use installation conduit with max. Ø 16mm

652-004010001	
652-004010008	
652-004010005	
652-004010006	

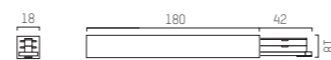

### MITTELSPEISUNG / CENTER POWER FEED

ACHTUNG: Installationsschlauch max. Ø 16mm verwenden / ATTENTION: Use installation conduit with max. Ø 16mm

652-004020001	
652-004020008	
652-004020005	
652-004020006	

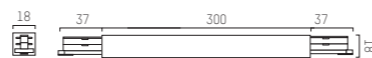

### ENDEINSPEISUNG / END POWER FEED

mit Baldachin / with canopy

652-004030001	
652-004030008	
652-004030005	
652-004030006	

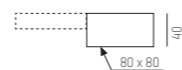

### MITTELSPEISUNG / CENTER POWER FEED

mit Baldachin / with canopy

652-004040001	
652-004040008	
652-004040005	
652-004040006	

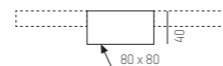

### MITTELSPEISUNG / CENTER POWER FEED

mit Baldachin, beliebig kürzbar, 5 x 1,0mm<sup>2</sup> / with canopy, cut to any length, 5 x 1,0mm<sup>2</sup>

652-004050001		L: 1000mm
652-004050008		L: 1000mm
652-004050005		L: 1000mm
652-004050006		L: 1000mm

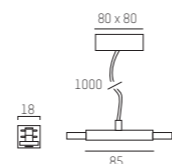

### KABELNDEINSPEISUNG / CABLE END POWER FEED

mit Baldachin, beliebig kürzbar, 5 x 1,0mm<sup>2</sup> / with canopy, cut to any length, 5 x 1,0mm<sup>2</sup>

652-004070001		L: 2000mm
652-004070008		L: 2000mm
652-004070005		L: 2000mm
652-004070006		L: 2000mm

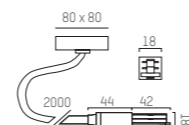

### KABELNDEINSPEISUNG / CABLE END POWER FEED

ohne Baldachin, beliebig kürzbar, 5 x 1,0mm<sup>2</sup> / without canopy, cut to any length, 5 x 1,0mm<sup>2</sup>

652-004080001		L: 2000mm
652-004080008		L: 2000mm
652-004080005		L: 2000mm
652-004080006		L: 2000mm



### VOLARE ADAPTER / VOLARE ADAPTER

zur Befestigung von Pendelleuchten, max. Tragkraft 5kg / for fixing pendants, max. load 5kg

652-008020001	
652-008020004	
652-008020005	
652-008020006	



### BLINDABDECKUNG / ALUMINIUM COVER

Für 2-Phasen Schiene, inkl. 6 Stk. Halteclips / for 2-phase track incl. 6 pcs. holding clips

652-005010001		L: 1000mm
652-005010008		L: 1000mm
652-005010005		L: 1000mm
652-005010006		L: 1000mm

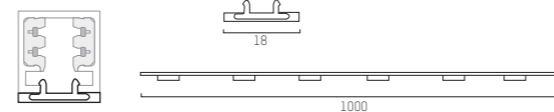



IRIS S GLAS / GLASS



CH champagner  
champagner

B chrom  
chrome

P pink  
pink

BASS GLAS / GLASS



CH champagner  
champagner

B chrom  
chrome

RG rauchgrau  
smoked grey

Dekorative Hängeleuchte aus Aluminium in schwarz pulverbeschichtet. Kombinierbar mit 2 verschiedenen mundgeblasenen Gläsern in je drei Farben. Pende und Leuchtgläser separat ordern.

Decorative pendant lamp made of aluminium in black powder-coated. Can be combined with 2 different mouth-blown glasses in three colours each. Order pendant and lamp glasses separately.

Lampada decorativa a sospensione in alluminio verniciato a polveri in nero. Combinabile con due diversi vetri soffiati, in tre colori differenti. Sospensioni e vetri da ordinare separatamente

Lampe décorative suspendue en aluminium thermo-laqué noir. Combinable avec deux verres soufflés de trois couleurs différentes. La suspension et le verre doivent être commandés séparément

VOLARE Schienensystem: Seite 14-17  
VOLARE track system: page 14-17

IP 20

**LOUM**

**CORPA VOLARE**

1 x QPAR 16- GU10 · 230V · max. 9W Retrofit

257-100186X0

Empfohlene Leuchtmittel / recommended bulbs:

QPAR 16- 6,2W · CRI>90 · 2700K · 575lm 30-675417  
QPAR 16- 6,2W · CRI>90 · 3000K · 575lm 30-705251

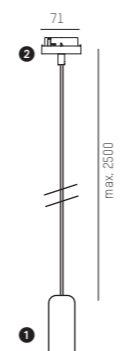

**IRIS S GLAS / GLASS**

mundgeblasen, separat ordern  
mouthblown order separatly

733-000100h0   
733-000100a0   
733-000100p0

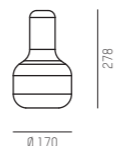

**BASS GLAS / GLASS**

mundgeblasen, separat ordern  
mouthblown order separatly

732-000000h0   
732-000000a0   
732-000000g0

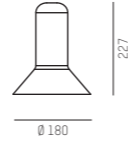

ARTIKELNUMMER ERGÄNZEN / COMPLETE CODE

X = FARBE/COLOUR ADAPTER

- chrome = 1
- silver matt = 4
- white = 5
- black = 6





LOON MINI + Glas amber  
LOON MINI + glass amber



LOON MINI + Glas grau  
LOON MINI + glass grey



LOON MINI + Glas braun  
LOON MINI + glass brown

Dekorative Hängeleuchte im Retro-Design.  
Hochwertige Glaskugel mundgeblasen in 3 Farben.  
Speziell konstruierte Fassung für bündigen Montage.  
Abhängung in 2 Farben erhältlich.  
Glasschirm separat ordern.

Decorative suspended luminaire in retro design.  
High-quality blown glass ball in 3 different colours.  
Special socket construction for flush mounting.  
Suspension cable available in 2 colours.  
Please order glass shade separately.

Sospensione con design decorativo.  
Sfera di vetro soffiato in 3 colori differenti.  
Portalampana speciale per montaggio a filo.  
Cavo di sospensione disponibile in 2 colori.  
Schermo in vetro da ordinare separatamente.

Suspension decorative.  
Boule en verre soufflé 3 couleurs au choix.  
Douille de lampe spéciale.  
Câble de suspension disponible en 2 couleurs.  
Commander l'abat-jour de verre séparément.

**VOLARE Schienensystem: Seite 14-17**  
**VOLARE track system: page 14-17**

IP20

**LOUM**®

**LOON MINI VOLARE**

Pende (Glas separat ordern)  
suspension (order glass separately)

1 x D45 ECO · E14 · 230V · max. 30W or  
1 x LED RETROFIT · E14

**636-30X1**   
**636-30X6**

Empfohlenes Leuchtmittel / recommended bulb:

E14 · D45 · 5W · CRI>80 · 2500K · 410lm **30-815670**

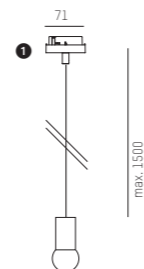

**ARTIKELNUMMER ERGÄNZEN / COMPLETE CODE**

**X = FARBE/COLOUR ADAPTER**

- 1**
- white = 5
- black = 6
- silver matt = 4
- chrome = 1

**LOON MINI BALL GLAS / GLASS**

separat ordern / order separately

**636-600g**   
**636-600a**   
**636-600b**

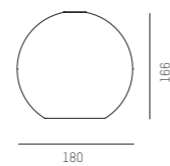

**LOON MINI BALL VOLARE**

Design: INHOUSE

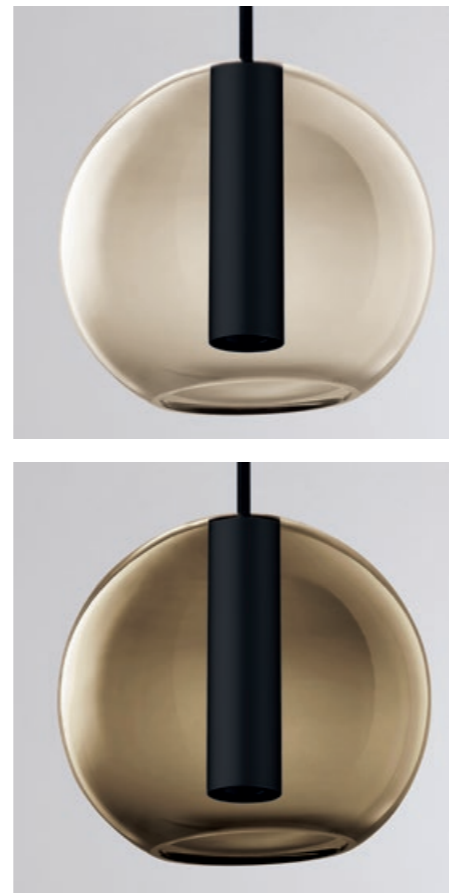

LED Pendelleuchte aus Aluminium.  
Schwarz pulverbeschichtet.  
Zurückversetzte Linsen mit verschiedenen Abstrahlwinkeln.  
Lichtaustrittsfläche von nur 10 mm.  
Perfekte Entblendung und erhöhter Sehkomfort.

LED pendant in aluminium.  
Black powder coated.  
Recessed lenses with different beam-angles.  
Light exit field with only 10 mm.  
Perfect glare control and increased visual comfort.

Incasso LED in alluminio.  
Polvere in nero.  
Lenti spostati indietro con varie emissioni.  
Dispositivo di illuminazione di soli 10 mm.  
Controllo anti-abbagliamento per un elevato comfort visivo.

Encastré LED en aluminium.  
Vernissé à poudres en noir.  
Lentes déplacés au fond avec d'émissions différentes.  
Plus que 10 mm de surface d'émission de lumière.  
Control anti-éblouissement et confort visuel optimal.

W2 = LED 2700K  
W3 = LED 3000K

VOLARE Schienensystem: Seite 14-17  
VOLARE track system: page 14-17

IP 20

LFO Lens-Technology by Bartenbach

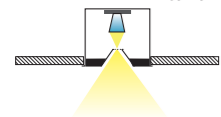

### TRIGGA LOON MINI VOLARE

220-240V AC · CRI >90 · Binning SDCM 3  
TRIGGA nur in schwarz erhältlich  
TRIGGA available in black only

SYS 6W

662-018020223XX0 230lm  
662-018020229XX0 250lm

662-018020523XX0 270lm  
662-018020529XX0 290lm

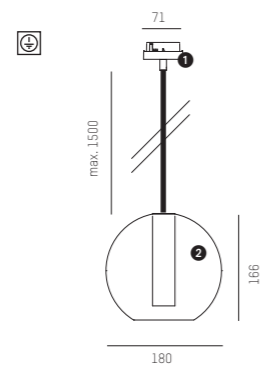

### TRIGGA LOON MINI VOLARE DIMM

220-240V AC · CRI >90 · Binning SDCM 3  
TRIGGA nur in schwarz erhältlich  
TRIGGA available in black only

SYS 6W

662-019020223XXY 230lm  
662-019020229XXY 250lm

662-019020523XXY 270lm  
662-019020529XXY 290lm

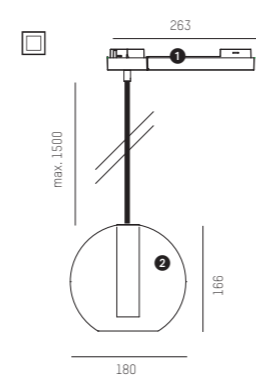

### ARTIKELNUMMER ERGÄNZEN / COMPLETE CODE

XX = FARBE/COLOUR

1	W	white = 5	2	AM	black-amber = 7
	S	black = 6		B	black-brown = 8
	SM	silver matt = 4		G	black-grey = 9
	C	chrome = 1			

Y = DIMMBAR / DIMMABLE

LOXONE AIR dimm = r  
 Zigbee dimm = z

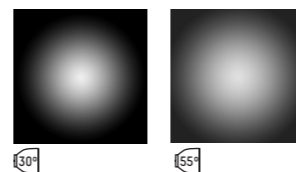



LED Pendelleuchte aus Aluminium in schwarz.  
Das mundgeblasene mattierte Opalglas in  
Lamellenform erzeugt eine puristische Eleganz.  
Kabel schwarz

LED pendant luminaire made of aluminium in black  
with mouth-blown frosted opal glass in lamella form  
creates a puristic elegance.  
Black cable

Sospensione a LED in alluminio in finitura nera  
con vetro soffiato opale e satinato a forma di lamelle,  
che dona un'eleganza minimale.  
Cavo nero

Suspension de LED en aluminium en finition noire  
avec verre soufflé opale et satiné en forme de lamelles,  
ce qui donne une élégance minimale.  
Câble noir

W3 = LED 3000K

VOLARE Schienensystem: Seite 14-17  
VOLARE track system: page 14-17

IP 20

**LOUM**<sup>®</sup>

YAJO 1 VOLARE

Design: LOUM

**YAJO 1 VOLARE**

220-240V AC · CRI >80 · Binning SDCM 3

**LOXONE** Ready

SYS 16W

729-100396XY 900lm

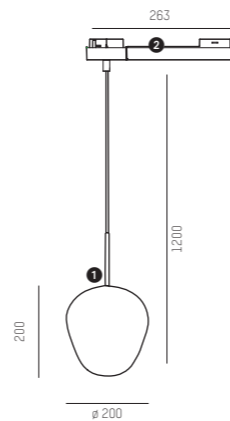

ARTIKELNUMMER ERGÄNZEN / COMPLETE CODE

**X** = FARBE/COLOUR ADAPTER

- chrome = 1
- silver matt = 4
- white = 5
- black = 6

**Y** = DIMMBAR / DIMMABLE

- switchable = 0
- LOXONE AIR dimm = r
- Zigbee dimm = z





Shade grey - light on



Shade grey - light off

Dekorative Schirmleuchte.  
Struktur aus Metal in schwarz.  
Stoff schwer entflammbar nach DIN 4102 B1.  
Schirm und Pende separat ordern.

Decorative shades in different size.  
Metal structure in black.  
Fire resistant fabric according to DIN 4102 B1.  
Order shade and pendant separately.

Paralume decorativo disponibile.  
Struttura metallica in nero.  
Tessuto ingnifugo secondo DIN 4102 B1.  
Paralume e portalampana da ordinare separatamente.

Abat-jour décoratif en tissu proposé.  
Structure métallique noir.  
Tissu ignifugé selon norme DIN 4102 B1.  
Abat-jour et suspension à commander séparément.

**VOLARE Schienensystem: Seite 14-17**  
**VOLARE track system: page 14-17**

IP 20

**LOUM**<sup>®</sup>

### BIVIO VOLARE

Pende (Schirm separat ordern)  
suspension (order shade separately)

1 x A60 ECO · E27 · 230V · max. 46W or  
1 x LED RETROFIT · E27

**645-008000000XX0**

Empfohlenes Leuchtmittel / recommended bulb:

E27 · A60 · 5,5W · CRI>80 · 2000K · 250lm **30-686543**



### SCHIRM SYMMETRISCH / SHADE SYMMETRIC

separat ordern / order separately

**645-006030000120**

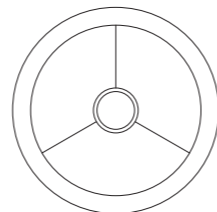
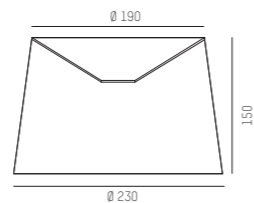

ARTIKELNUMMER ERGÄNZEN / COMPLETE CODE

**XX** = FARBE/COLOUR ADAPTER

white = **55**  
 black = **66**  
 silver matt = **44**  
 chrome = **11**





Dekorative Hängeleuchte aus Aluminium in schwarz pulverbeschichtet. Leuchten in zwei unterschiedlichen Versionen erhältlich. LEO 2 mit mundgeblasenem Rauchglasschirm. Leuchtmittel separat ordern.

Decorative pendant lamp made of aluminium in black powder-coated. Luminaires available in two different versions. LEO 2 with hand-blown smoked glass shade. Lamps to be ordered separately.

Lampada decorativa a sospensione in alluminio verniciato a polveri in nero. Lampada disponibile in due versioni. LEO 2 con vetro soffiato fumé. Lampadina da ordinare separatamente

Lampe décorative suspendue en aluminium thermo-laqué noir. Lampe disponible en deux versions LEO 2 avec verre soufflé fumé. Ampoule à commander séparément

**VOLARE Schienensystem: Seite 14-17**  
**VOLARE track system: page 14-17**

IP 20

**LOUM**

**LEO 1 VOLARE**

1 x QPAR 16- GU10 · 230V · max. 9W Retrofit

738-100686X0

**LEO 2 VOLARE**

1 x QPAR 16- GU10 · 230V · max. 9W Retrofit

257-100786X0

Empfohlene Leuchtmittel / recommended bulbs:

QPAR 16- 6,2W · CRI>90 · 2700K · 575lm · 30-675417  
QPAR 16- 6,2W · CRI>90 · 3000K · 575lm · 30-705251

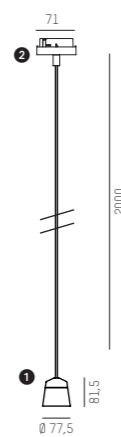

ARTIKELNUMMER ERGÄNZEN / COMPLETE CODE

X = FARBE/COLOUR ADAPTER

- chrome = 1
- silver matt = 4
- white = 5
- black = 6





Dekorative designreduzierte Hängeleuchte in schwarz, weiß oder kupfer. Hochwertig gearbeitete Lampenfassung aus Aluminium. Inkl. 2500mm Kabel in schwarz oder weiß.

Decorative design reduced pendant lamp in black, white or copper. High quality lamp socket made of aluminium. Incl. 2500mm cable in black or white.

Lampada decorativa a sospensione in nero, bianco o rame. Portalampana di alta qualità in alluminio. Cavo da 2500mm in bianco o nero incluso

Lampe décorative suspendue en noir, blanc ou cuivre. Douille en aluminium de haute qualité. Câble noir ou blanc de 2500 mm inclus

**VOLARE Schienensystem: Seite 14-17**  
**VOLARE track system: page 14-17**

IP 20

**LOUM**<sup>®</sup>

**PEYA VOLARE**

1 x E27 · A60 · 220-240V · max. 9W Retrofit

**727-10018XX0**

Empfohlene Leuchtmittel / recommended bulbs:

E27 · A60 · 5,5W · CRI>80 · 2000K · 250lm **30-686543**

E27 · ST64 · 5,5W · CRI>80 · 2000K · 250lm **30-686567**

E27 · G200 · 5W · CRI>80 · 2000K · 300lm **30-768129**

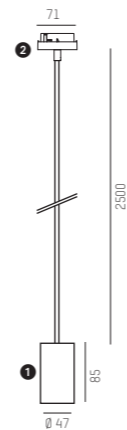

**ARTIKELNUMMER ERGÄNZEN / COMPLETE CODE**

**XX** = FARBE/COLOUR

<b>1</b>	<b>W</b> white = 5	<b>2</b>	<b>C</b> chrome = 1
	<b>S</b> black = 6		<b>SM</b> silver matt = 4
	<b>KU</b> copper = 7		<b>W</b> white = 5
			<b>S</b> black = 6







LED Pendelleuchte aus Gips mit organisch fließender Formgebung. In den Farben schwarz oder weiß erhältlich. Inkl. Opalglas-Abdeckung für diffusere Lichtabstrahlung. Sehr dezentes Kabel in den Farben schwarz oder weiß.

LED pendant luminaire made of plaster with organic flowing design. Available in black or white. Including opal glass cover for more diffuse light emission. Very discreet cable in the colours black or white.

Lampada LED a sospensione in gesso dalla forma organica in movimento. Disponibile in finitura nera o bianca schermo opale per luce diffusa incluso. Cavo molto discreto disponibile in bianco o nero

Lampe LED suspendue en plâtre avec une forme organique en mouvement. Disponible en finition noire ou blanche. Écran opale pour lumière diffuse inclus câble très discret disponible en noir ou en blanc

W3 = LED 3000K

VOLARE Schienensystem: Seite 14-17  
VOLARE track system: page 14-17

IP 20

**LOUM**<sup>®</sup>

**FIUME VOLARE**

220-240V AC · CRI >90 · Binning SDCM 3

**LOXONE** Ready

SYS 6W

738-100895XY 450lm  
738-100896XY 450lm

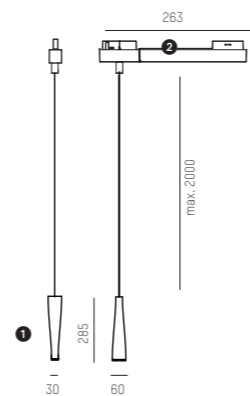

ARTIKELNUMMER ERGÄNZEN / COMPLETE CODE

**X** = FARBE/COLOUR ADAPTER

- chrome = 1
- silver matt = 4
- white = 5
- black = 6

**Y** = DIMMBAR / DIMMABLE

- switchable = 0
- LOXONE AIR dimm = r
- Zigbee dimm = z





Zylindrische LED Pendelleuchte.  
Leuchtenkörper erhältlich in zwei unterschiedlichen Längen. Verfügbar in den Farben schwarz, weiß oder roségold. Ausstrahlwinkel 36°, inkl. 1500mm Abhängung in schwarz.

Cylindrical LED pendant luminaire.  
Lamp body available in two different lengths. Available in black, white or rose gold. Beam angle 36°, incl. 1500mm suspension in black.

Lampada LED a sospensione di forma cilindrica.  
Corpo lampada disponibile in due lunghezze. Disponibile nei colori nero, bianco oppure oro rosato. Fascio d'apertura 36°, sospensione 1500mm nera inclusa.

Lampe suspendue cylindrique à LED.  
Corps de lampe disponible en deux longueurs. Disponible en noir, blanc ou or rosé. Faisceau d'ouverture 36°, suspension 1500mm noire incluse.

W2 = LED 2700K  
W3 = LED 3000K

VOLARE Schienensystem: Seite 14-17  
VOLARE track system: page 14-17

IP20

**LOUM**<sup>®</sup>

**DIVO VOLARE**

Design: LOUM

**DIVO SHORT VOLARE**

220-240V AC · CRI >90 · Binning SDCM 3

**LOXONE Ready**

SYS 12W

305-10023XXY W2 860lm  
305-10029XXY W3 860lm

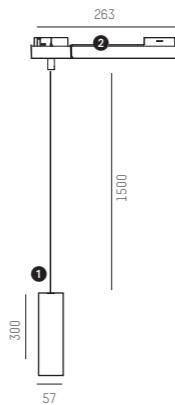

**DIVO LONG VOLARE**

220-240V AC · CRI >90 · Binning SDCM 3

**LOXONE Ready**

SYS 12W

305-10033XXY W2 860lm  
305-10039XXY W3 860lm

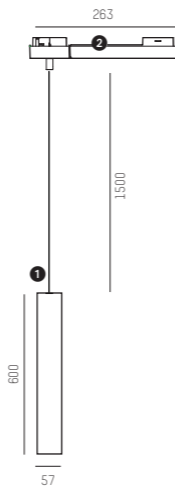

**ARTIKELNUMMER ERGÄNZEN / COMPLETE CODE**

**XX** = FARBE/COLOUR

- W white = 5
- S black = 6
- RG rosegold = r

- C chrome = 1
- SM silver matt = 4
- W white = 5
- S black = 6

**Y** = DIMMBAR / DIMMABLE

- S switchable = 0
- L LOXONE AIR dimm = r
- Z Zigbee dimm = z





LED Pendelleuchte aus Aluminium.  
Weiß oder schwarz pulverbeschichtet.  
Reflektor in 4 Farben erhältlich.  
inkl. 3000mm Abhängung.

LED pendant in aluminium.  
White or black powder coated.  
Reflector available in 4 colours.  
Incl. 3000mm suspension.

Incasso LED in alluminio.  
Verniciato a polvere in bianco o nero.  
Riflettore disponibile in 4 colori.  
Incl. 3000mm di sospensione.

Encastré LED en aluminium.  
Vernissé à poudres en blanc ou noir.  
Réflecteur disponible en 4 couleurs.  
Avec 3000mm de suspension.

W2 = LED 2700K Premium CRI>90  
W3 = LED 3000K Premium CRI>90  
W4 = LED 4000K CRI>90

LED 3500K auf Anfrage / on request

VOLARE Schienensystem: Seite 14-17  
VOLARE track system: page 14-17

IP 20

### DARK NIGHT XS VOLARE

220-240V AC · CRI >90 · Binning SDCM 3

LOXONE Ready

SYS 17W

684-007RR0543XXY 1160lm  
684-007RR0549XXY 1210lm  
684-007RR0524XXY 1290lm

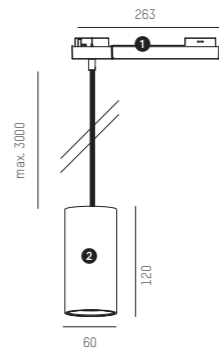

#### ARTIKELNUMMER ERGÄNZEN / COMPLETE CODE

RR = FARBE REFL. / COLOUR REFL.

silver = 02  
 black = 03  
 gold = 04  
 white = 06

XX = FARBE / COLOUR

white = 5  
 black = 6  
 silver matt = 4  
 chrome = 1

Y = DIMMBAR / DIMMABLE

switchable = 0  
 LOXONE AIR dimm = r  
 Zigbee dimm = z

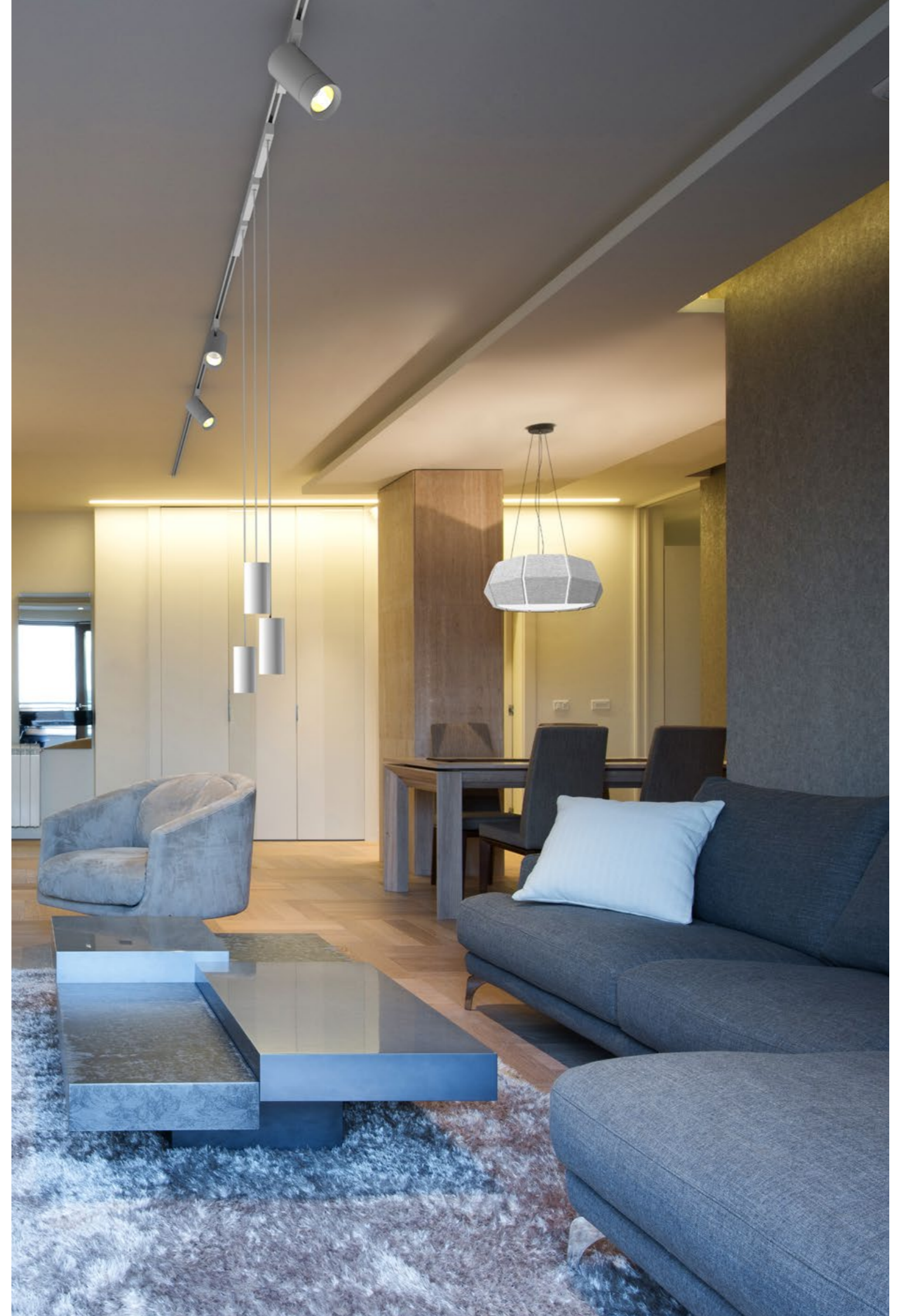

# DARK NIGHT VOLARE

Design: INHOUSE

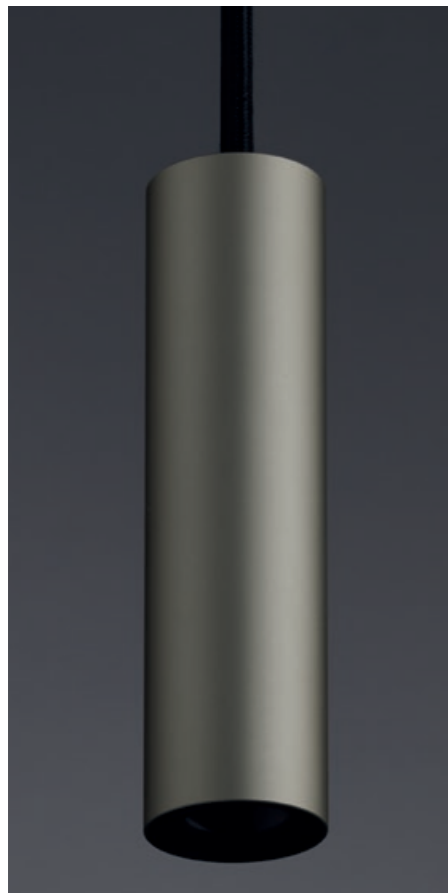

LED Pendelleuchte aus Aluminium.  
 Bronze eloxiert, weiß oder schwarz pulverbeschichtet.  
 Zurückversetzte Linsen mit verschiedenen Abstrahlwinkeln.  
 Lichtaustrittsfläche von nur 10 mm.  
 Perfekte Entblendung und erhöhter Sehkomfort.

LED pendant in aluminium.  
 Bronze anodized, white or black powder coated.  
 Recessed lenses with different beam-angles.  
 Light exit field with only 10 mm.  
 Perfect glare control and increased visual comfort.

Incastré LED en aluminium.  
 Bronze anodizzato, verniciato a polvere in bianco o nero.  
 Lenti spostati indietro con varie emissioni.  
 Dispositivo di illuminazione di soli 10 mm.  
 Controllo anti-abbagliamento per un elevato comfort visivo.

Encastré LED en aluminium.  
 Bronze anodisé, vernissé à poudre en blanc ou noir.  
 Lentilles déplacées au fond avec des émissions différentes.  
 Plus que 10 mm de surface d'émission de lumière.  
 Contrôle anti-éblouissement et confort visuel optimal.

W2 = LED 2700K  
 W3 = LED 3000K

VOLARE Schienensystem: Seite 14-17  
 VOLARE track system: page 14-17

IP 20

LF0 Lens-Technology by Bartenbach

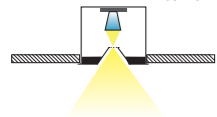

### TRIGGA SHORT VOLARE

220-240V AC · CRI >90 · Binning SDCM 3

SYS 6W

662-002020223XX0 230lm H: 140mm  
 662-002020229XX0 250lm H: 140mm

662-002020523XX0 270lm H: 140mm  
 662-002020529XX0 290lm H: 140mm

### TRIGGA LONG VOLARE

220-240V AC · CRI >90 · Binning SDCM 3

SYS 6W

662-003020223XX0 230lm H: 280mm  
 662-003020229XX0 250lm H: 280mm

662-003020523XX0 270lm H: 280mm  
 662-003020529XX0 290lm H: 280mm

### TRIGGA XL VOLARE

220-240V AC · CRI >90 · Binning SDCM 3

SYS 6W

662-020020223XX0 230lm H: 420mm  
 662-020020229XX0 250lm H: 420mm

662-020020523XX0 270lm H: 420mm  
 662-020020529XX0 290lm H: 420mm

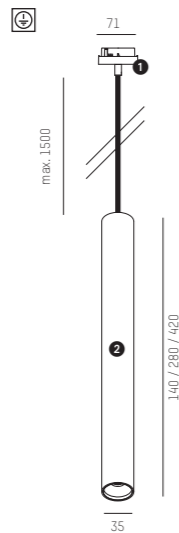

### TRIGGA SHORT VOLARE DIMM

**LOXONE Ready**

220-240V AC · CRI >90 · Binning SDCM 3

SYS 6W

662-015020223XXY 230lm H: 140mm  
 662-015020229XXY 250lm H: 140mm

662-015020523XXY 270lm H: 140mm  
 662-015020529XXY 290lm H: 140mm

### TRIGGA LONG VOLARE DIMM

**LOXONE Ready**

220-240V AC · CRI >90 · Binning SDCM 3

SYS 6W

662-016020223XXY 230lm H: 280mm  
 662-016020229XXY 250lm H: 280mm

662-016020523XXY 270lm H: 280mm  
 662-016020529XXY 290lm H: 280mm

### TRIGGA XL VOLARE DIMM

**LOXONE Ready**

220-240V AC · CRI >90 · Binning SDCM 3

SYS 6W

662-022020223XXY 230lm H: 420mm  
 662-022020229XXY 250lm H: 420mm

662-022020523XXY 270lm H: 420mm  
 662-022020529XXY 290lm H: 420mm

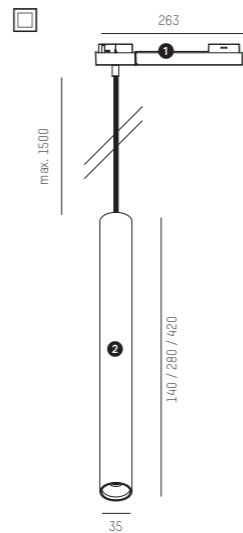

### ARTIKELNUMMER ERGÄNZEN / COMPLETE CODE

XX = FARBE/COLOUR

1 white = 5  
 black = 6  
 silver matt = 4  
 chrome = 1

2 white = 5  
 black = 6  
 bronze anodized = 2

Y = DIMMBAR / DIMMABLE

L LOXONE AIR dimm = r  
 Z Zigbee dimm = z

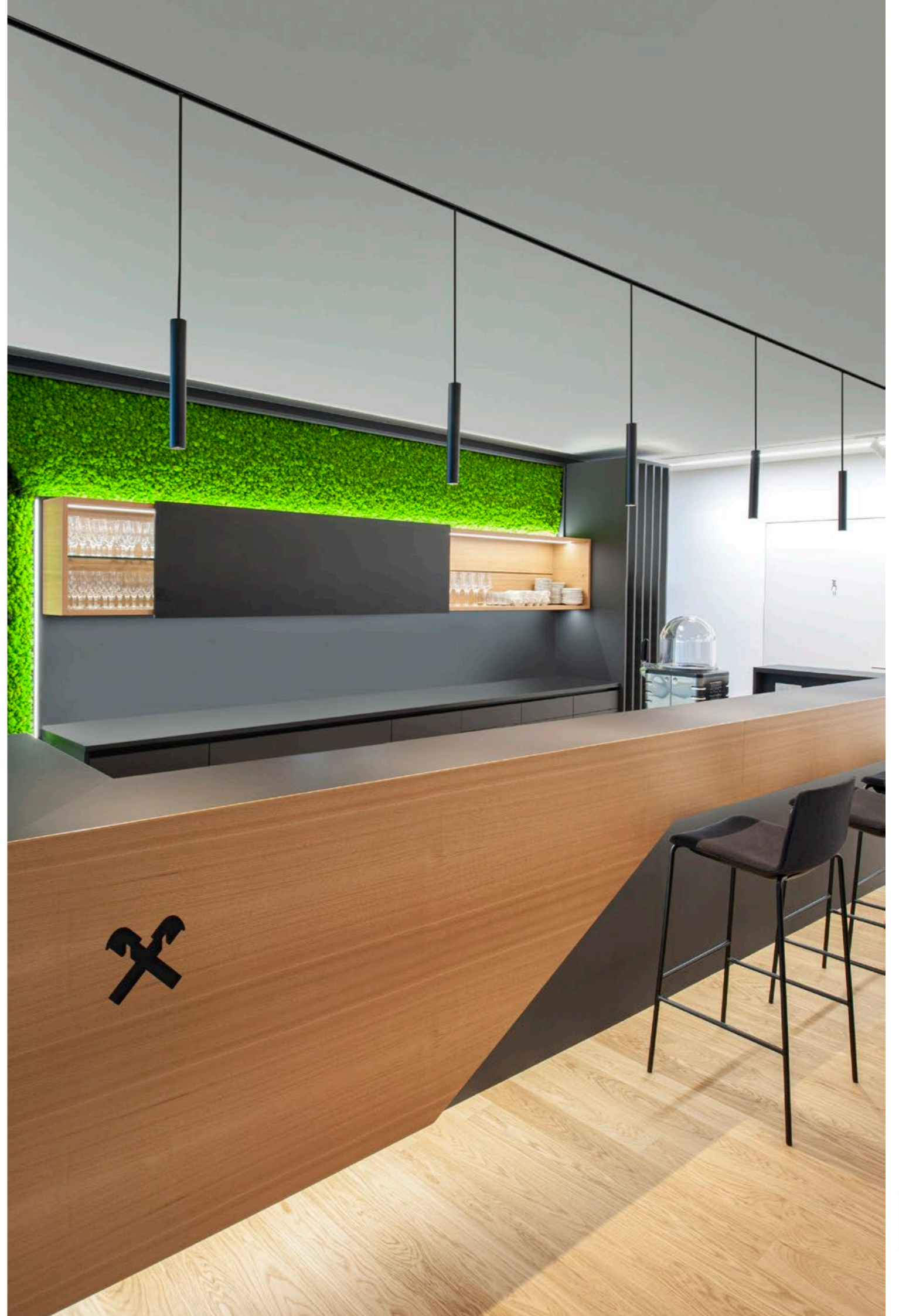
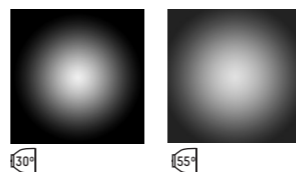



LED Schienenstrahler aus Aluminium.  
Oberfläche in weiß oder schwarz pulverbeschichtet.  
Zurückversetzte Linsen mit verschiedenen Abstrahlwinkeln.  
Lichtaustrittsfläche von nur 10 mm.  
Perfekte Entblendung und erhöhter Sehkomfort.

LED track spot in aluminium.  
White or black finish powder coated.  
Recessed lenses with different beam-angles.  
light exit field with only 10 mm.  
Perfect glare control and increased visual comfort.

Proiettore LED per binario in alluminio.  
Verniciatura a polveri in bianco o nero.  
Lenti spostati indietro con varie emissioni.  
Dispositivo di illuminazione di soli 10 mm.  
Controllo anti-abbagliamento per un elevato comfort visivo.

Projecteur à LED en aluminium.  
Vernissage ó poudres en blanc ou noir.  
Lentes déplacés au fond avec d'émissions différentes.  
Plus que 10 mm de surface d'émission de lumière.  
Control anti-éblouissement et confort visuel optimal.

W2 = LED 2700K  
W3 = LED 3000K

VOLARE Schienensystem: Seite 14-17  
VOLARE track system: page 14-17

IP 20

LF0 Lens-Technology by Bartenbach

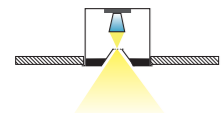

### TRIGGA SPOT VOLARE

220-240V AC · CRI >90 · Binning SDCM 3

SYS 6W

662-001020223XX0 230lm  
662-001020229XX0 250lm

662-001020523XX0 270lm  
662-001020529XX0 290lm

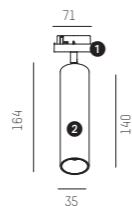

### TRIGGA SPOT VOLARE DIMM

**LOXONE Ready**

220-240V AC · CRI >90 · Binning SDCM 3

SYS 11W

662-014020223XXY 380lm  
662-014020229XXY 410lm

662-014020523XXY 440lm  
662-014020529XXY 470lm

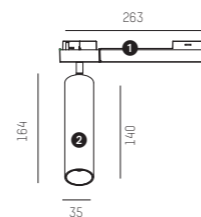

### ARTIKELNUMMER ERGÄNZEN / COMPLETE CODE

XX = FARBE/COLOUR

1 white = 5      2 white = 5  
S black = 6      S black = 6  
SM silver matt = 4  
C chrome = 1

Y = DIMMBAR / DIMMABLE

L LOXONE AIR dimm = r  
Z Zigbee dimm = z

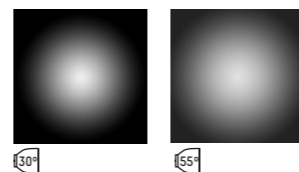



VIBO weiß + Dekorring schwarz  
VIBO white + decor ring black



Schienstrahler aus Aluminium.  
Oberfläche in weiß oder schwarz pulverbeschichtet.  
Spezielle Linsenoptik ohne Streulicht.  
Dekorring in weiß oder schwarz pulverbeschichtet.

Track spotlight in aluminium.  
Black or white powder-coated surface.  
Special lens optics without scattered light.  
Decoration ring black or white powder-coated.

Faretto da binario in alluminio.  
Verniciatura a polvere in bianco o nero.  
Ottica speciale senza luce diffusa.  
Anello decorativo verniciato a polvere in nero o bianco.

Projecteur sur rail en aluminium.  
Finition laquée blanc ou noir.  
Lentille optique sans lumière parasite.  
Anneau décoratif laqué noir ou blanc.

**VOLARE Schienensystem: Seite 14-17**  
**VOLARE track system: page 14-17**

IP 20

### VIBO VOLARE

220 - 240V AC · CRI >90 · Binning SDCM 3

SYS 8W

	lm <b>W2</b>	lm <b>W3</b>	lm <b>W4</b>
668-00401022 <b>WXX0</b>	410	440	470
668-00401052 <b>WXX0</b>	410	440	470
668-00401082 <b>WXX0</b>	340	360	390

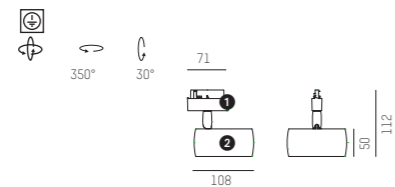

### VIBO VOLARE DIMM

**LOXONE Ready**

220 - 240V AC · CRI >90 · Binning SDCM 3

SYS 8W

	lm <b>W2</b>	lm <b>W3</b>	lm <b>W4</b>
668-00501022 <b>WXXY</b>	410	440	470
668-00501052 <b>WXXY</b>	410	440	470
668-00501082 <b>WXXY</b>	340	360	390

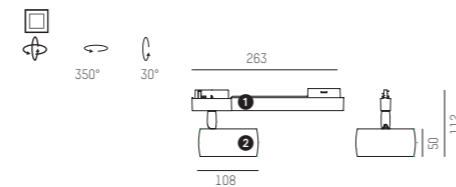

### VIBO DEKORRING / VIBO DECOR RING

für 2-färbige Varianten, separat ordern / for bic-coloured versions, order separately

668-000105   
668-000106

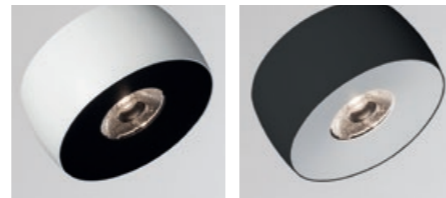

### ARTIKELNUMMER ERGÄNZEN / COMPLETE CODE

**W** = LICHTFARBE/LIGHT COLOUR

**XX** = FARBE/COLOUR

**Y** = DIMMBAR / DIMMABLE

LED 2700K = 3  
 LED 3000K = 9  
 LED 4000K = 4

white = 5  
 black = 6  
 silver matt = 4  
 chrome = 1

white = 5  
 black = 6

LOXONE AIR dimm = r  
 Zigbee dimm = z



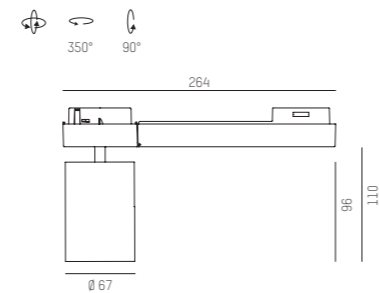

LED Schienenstrahler aus Aluminiumdruckguss.  
Feinstrukturlack in weiß, schwarz oder silber matt.  
Reflektor in 3 Ausstrahlwinkel.  
LED Konverter im Adapter integriert.  
Wahlweise dimmbar mit ZigBee 3.0 oder Loxone Air.

LED track spotlight made of die-cast aluminium.  
Fine textured paint in white, black or silver matt.  
Reflector in 3 beam angles.  
LED converter integrated in the adapter.  
optionally dimmable with ZigBee 3.0 or Loxone Air.

Proiettore LED in alluminio pressofuso.  
Verniciatura in bianco, nero oppure grigio opaco.  
Riflettore in 3 fasci d'apertura.  
Alimentatore LED integrato nell'adattatore.  
Possibilità di dimmerazione con ZigBee 3.0 o Loxone Air.

Projecteur LED en aluminium moulé sous pression.  
Peinture en blanc, noir ou gris mat.  
Réflecteur en 3 faisceaux d'ouverture.  
Alimentation LED intégrée dans l'adaptateur.  
Possibilité de gradation avec ZigBee 3.0 ou Loxone Air.

**VOLARE Schienensystem: Seite 14-17**  
**VOLARE track system: page 14-17**

**MOVA Configurator: [www.moltoluca.com](http://www.moltoluca.com)**

IP 20

**MOVA S BASIC VOLARE**

**LOXONE Ready**

220-240V AC · Binning SDCM 3 | **BASIC REFLECTOR**

SYS 8W

	W2	W3	W4
495-22CXb12WWXXY	760lm	850lm	930lm
495-22CXb13WWXXY	760lm	850lm	930lm
495-22CXb14WWXXY	760lm	850lm	930lm

SYS 16W

	W2	W3	W4
495-22CXc12WWXXY	1440lm	1610lm	1770lm
495-22CXc13WWXXY	1440lm	1610lm	1770lm
495-22CXc14WWXXY	1440lm	1610lm	1770lm

**MOVA S DARK VOLARE**

**LOXONE Ready**

220-240V AC · Binning SDCM 3 | **DARK REFLECTOR**

SYS 8W

	W2	W3	W4
495-22CXb42WWXXY	390lm	440lm	480lm
495-22CXb43WWXXY	440lm	490lm	540lm
495-22CXb44WWXXY	500lm	570lm	620lm

SYS 16W

	W2	W3	W4
495-22CXc42WWXXY	730lm	820lm	900lm
495-22CXc43WWXXY	830lm	930lm	1020lm
495-22CXc44WWXXY	950lm	1070lm	1170lm

**MOVA KONFIGURATOR / MOVA CONFIGURATOR**

[www.moltoluca.com](http://www.moltoluca.com)

Zubehör, Sensor, Farbkombinationen und Sonderlichtfarben abrufbar über unseren MOVA Konfigurator auf [www.moltoluca.com](http://www.moltoluca.com)

Accessories, Sensor, colour combinations and special light colours available via our MOVA configurator on [www.moltoluca.com](http://www.moltoluca.com)



**ARTIKELNUMMER ERGÄNZEN / COMPLETE CODE**

**C** = COVER

**WW** = LICHTFARBE/LIGHT COLOUR

**X.....XX** = FARBE/COLOUR

**Y** = DIMMBAR / DIMMABLE

without glass = 0  
with glass = 1

W2	LED 2700K = 43	PREMIUM CRI >90
W3	LED 3000K = 49	PREMIUM CRI >90
W4	LED 4000K = 24	CRI >90

SM	silver matt = 4.....44
W	white = 5.....55
S	black = 6.....66

S	switchable = 0
L	LOXONE AIR dimm = r
Z	Zigbee dimm = z

**MOVA S BASIC / DARK VOLARE**

Design: INHOUSE

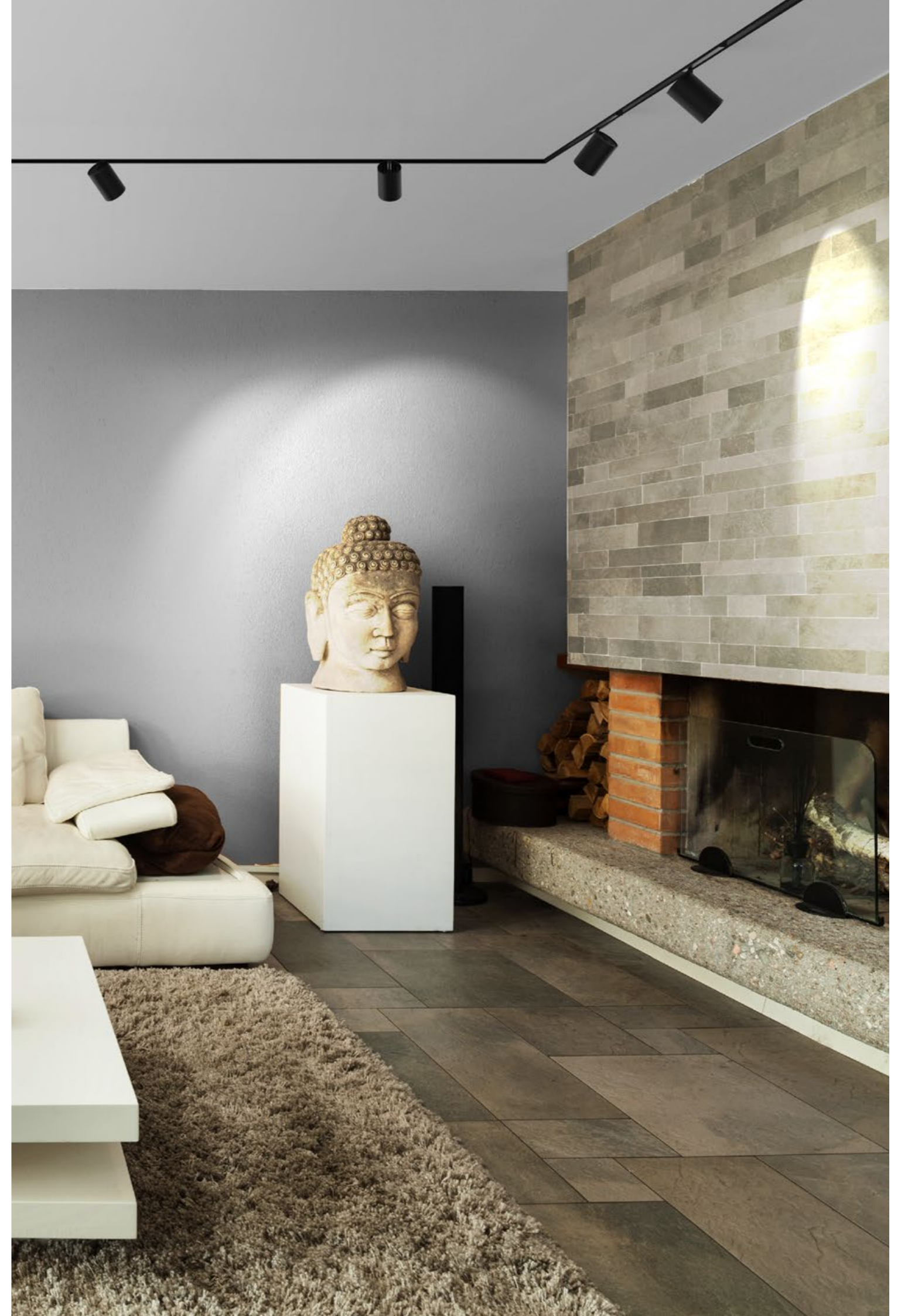

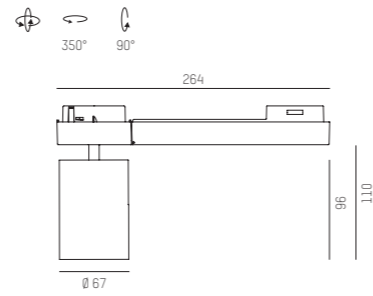

LED Schienenstrahler aus Aluminiumdruckguss.  
Feinstrukturlack in weiß, schwarz oder silber matt.  
Linse für ein exaktes Lichtbild ohne Streulichtwinkel.  
LED Konverter im Adapter integriert.  
Wahlweise dimmbar mit ZigBee 3.0 oder Loxone Air.

LED track spotlight made of die-cast aluminium.  
Fine textured paint in white, black or silver matt.  
Lens for an exact light image without scattered light angle.  
LED converter integrated in the adapter.  
Optionally dimmable with ZigBee 3.0 or Loxone Air.

Proiettore LED in alluminio pressofuso.  
Verniciatura in bianco, nero oppure grigio opaco.  
Lente ad alta precisione senza distorsioni.  
Alimentatore LED integrato nell'adattatore.  
Possibilità di dimmerazione con ZigBee 3.0 o Loxone Air.

Projecteur LED en aluminium moulé sous pression.  
Peinture en blanc, noir ou gris mat.  
Lentille de haute précision sans distorsion.  
Alimentation LED intégrée dans l'adaptateur.  
Possibilité de gradation avec ZigBee 3.0 ou Loxone Air.

**VOLARE Schienensystem: Seite 14-17**  
**VOLARE track system: page 14-17**

**MOVA Configurator: [www.moltoluce.com](http://www.moltoluce.com)**

IP 20

### MOVA S LENS VOLARE

220-240V AC - Binning SDCM 3

**LOXONE Ready**

#### SYS 8W

	W2	W3	W4
495-220X <b>b31</b> WWXXY	620lm	700lm	770lm
495-220X <b>b32</b> WWXXY	690lm	770lm	850lm
495-220X <b>b33</b> WWXXY	690lm	770lm	850lm
495-220X <b>b34</b> WWXXY	690lm	770lm	850lm

#### SYS 16W

	W2	W3	W4
495-220X <b>c31</b> WWXXY	1180lm	1320lm	1450lm
495-220X <b>c32</b> WWXXY	1300lm	1460lm	1600lm
495-220X <b>c33</b> WWXXY	1300lm	1460lm	1600lm
495-220X <b>c34</b> WWXXY	1300lm	1460lm	1600lm

#### MOVA KONFIGURATOR / MOVA CONFIGURATOR

[www.moltoluce.com](http://www.moltoluce.com)

Zubehör, Sensor, Farbkombinationen und Sonderlichtfarben abrufbar über unseren MOVA Konfigurator auf [www.moltoluce.com](http://www.moltoluce.com)

Accessories, Sensor, colour combinatons and special light colours available via our MOVA configurator on [www.moltoluce.com](http://www.moltoluce.com)



#### ARTIKELNUMMER ERGÄNZEN / COMPLETE CODE

**WW** = LICHTFARBE/LIGHT COLOUR

**X.....XX** = FARBE/COLOUR

**Y** = DIMMBAR / DIMMABLE

W2	LED 2700K = 43	PREMIUM CRI >90
W3	LED 3000K = 49	PREMIUM CRI >90
W4	LED 4000K = 24	CRI >90

SM	silver matt = 4.....44
W	white = 5.....55
S	black = 6.....66

S	switchable = 0
L	LOXONE AIR dimm = r
Z	Zigbee dimm = z

# MOVA S LENS VOLARE

Design: INHOUSE







With golden decoration ring:  
MOVA Configurator: [www.moltoluce.com](http://www.moltoluce.com)

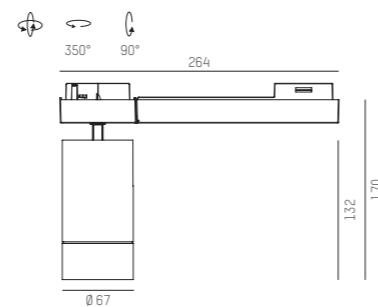

LED Schienenstrahler aus Aluminiumdruckguss.  
Feinstrukturlack in weiß, schwarz oder silber matt.  
Reflektor in 3 Ausstrahlwinkel.  
LED Konverter im Adapter integriert.  
Wahlweise dimmbar mit ZigBee 3.0 oder Loxone Air.

LED track spotlight made of die-cast aluminium.  
Fine textured paint in white, black or silver matt.  
Reflector in 3 beam angles.  
LED converter integrated in the adapter.  
optionally dimmable with ZigBee 3.0 or Loxone Air.

Proiettore LED in alluminio pressofuso.  
Verniciatura in bianco, nero oppure grigio opaco.  
Riflettore in 3 fasci d'apertura.  
Alimentatore LED integrato nell'adattatore.  
Possibilità di dimmerazione con ZigBee 3.0 o Loxone Air.

Projecteur LED en aluminium moulé sous pression.  
Peinture en blanc, noir ou gris mat.  
Réflecteur en 3 faisceaux d'ouverture.  
Alimentation LED intégrée dans l'adaptateur.  
Possibilité de gradation avec ZigBee 3.0 ou Loxone Air.

VOLARE Schienensystem: Seite 14-17  
VOLARE track system: page 14-17

MOVA Configurator: [www.moltoluce.com](http://www.moltoluce.com)

IP 20

### MOVA S L BASIC VOLARE

LOXONE Ready

220-240V AC · Binning SDCM 3 | BASIC REFLECTOR

SYS 8W

	W2	W3	W4
495-26CXb12WWXXY	360lm	400lm	430lm
495-26CXb13WWXXY	360lm	400lm	430lm
495-26CXb14WWXXY	360lm	400lm	430lm

SYS 16W

	W2	W3	W4
495-26CXc12WWXXY	670lm	750lm	820lm
495-26CXc13WWXXY	670lm	750lm	820lm
495-26CXc14WWXXY	670lm	750lm	820lm

### MOVA S L DARK VOLARE

LOXONE Ready

220-240V AC · Binning SDCM 3 | DARK REFLECTOR

SYS 8W

	W2	W3	W4
495-26CXb42WWXXY	200lm	230lm	250lm
495-26CXb43WWXXY	210lm	230lm	260lm
495-26CXb44WWXXY	180lm	210lm	230lm

SYS 16W

	W2	W3	W4
495-26CXc42WWXXY	370lm	420lm	460lm
495-26CXc43WWXXY	390lm	440lm	480lm
495-26CXc44WWXXY	340lm	390lm	420lm

MOVA KONFIGURATOR / MOVA CONFIGURATOR

[www.moltoluce.com](http://www.moltoluce.com)

Zubehör, Sensor, Farbkombinationen und Sonderlichtfarben abrufbar über unseren MOVA Konfigurator auf [www.moltoluce.com](http://www.moltoluce.com)

Accessories, Sensor, colour combinations and special light colours available via our MOVA configurator on [www.moltoluce.com](http://www.moltoluce.com)



#### ARTIKELNUMMER ERGÄNZEN / COMPLETE CODE

C = COVER

WW = LICHTFARBE/LIGHT COLOUR

X.....XX = FARBE/COLOUR

Y = DIMMBAR / DIMMABLE

without glass = 0  
with glass = 1

W2	LED 2700K = 43	PREMIUM CRI >90
W3	LED 3000K = 49	PREMIUM CRI >90
W4	LED 4000K = 24	CRI >90

SM	silver matt = 4.....44
W	white = 5.....55
S	black = 6.....66

S	switchable = 0
L	LOXONE AIR dimm = r
Z	Zigbee dimm = z

## MOVA S L BASIC / DARK VOLARE

Design: INHOUSE



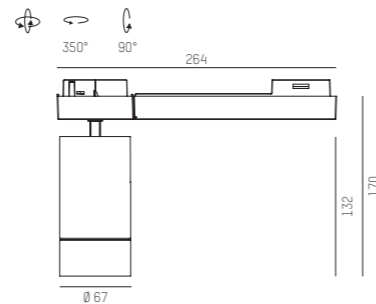

LED Schienenstrahler aus Aluminiumdruckguss.  
Feinstrukturlack in weiß, schwarz oder silber matt.  
Linse für ein exaktes Lichtbild ohne Streulichtwinkel.  
LED Konverter im Adapter integriert.  
Wahlweise dimmbar mit ZigBee 3.0 oder Loxone Air.

LED track spotlight made of die-cast aluminium.  
Fine textured paint in white, black or silver matt.  
Lens for an exact light image without scattered light angle.  
LED converter integrated in the adapter.  
Optionally dimmable with ZigBee 3.0 or Loxone Air.

Proiettore LED in alluminio pressofuso.  
Verniciatura in bianco, nero oppure grigio opaco.  
Lente ad alta precisione senza distorsioni.  
Alimentatore LED integrato nell'adattatore.  
Possibilità di dimmerazione con ZigBee 3.0 o Loxone Air.

Projecteur LED en aluminium moulé sous pression.  
Peinture en blanc, noir ou gris mat.  
Lentille de haute précision sans distorsion.  
Alimentation LED intégrée dans l'adaptateur.  
Possibilité de gradation avec ZigBee 3.0 ou Loxone Air.

**VOLARE Schienensystem: Seite 14-17**  
**VOLARE track system: page 14-17**

IP 20

### MOVA S L LENS VOLARE

220-240V AC - Binning SDCM 3

**LOXONE Ready**

#### SYS 8W

495-270X <b>b31</b> WWXXY	590lm	660lm	730lm
495-270X <b>b32</b> WWXXY	590lm	660lm	730lm
495-270X <b>b33</b> WWXXY	590lm	660lm	730lm
495-270X <b>b34</b> WWXXY	590lm	660lm	730lm

#### SYS 16W

495-270X <b>c32</b> WWXXY	1120lm	1250lm	1370lm
495-270X <b>c32</b> WWXXY	1120lm	1250lm	1370lm
495-270X <b>c33</b> WWXXY	1120lm	1250lm	1370lm
495-270X <b>c34</b> WWXXY	1120lm	1250lm	1370lm

#### MOVA KONFIGURATOR / MOVA CONFIGURATOR

[www.moltoluca.com](http://www.moltoluca.com)

Zubehör, Sensor, Farbkombinationen und Sonderlichtfarben abrufbar über unseren MOVA Konfigurator auf [www.moltoluca.com](http://www.moltoluca.com)

Accessories, Sensor, colour combinatons and special light colours available via our MOVA configurator on [www.moltoluca.com](http://www.moltoluca.com)



#### ARTIKELNUMMER ERGÄNZEN / COMPLETE CODE

**WW** = LICHTFARBE/LIGHT COLOUR

**X.....XX** = FARBE/COLOUR

**Y** = DIMMBAR / DIMMABLE

	LED 2700K = <b>43</b>	PREMIUM CRI >90
	LED 3000K = <b>49</b>	PREMIUM CRI >90
	LED 4000K = <b>24</b>	CRI >90

	silver matt = <b>4.....44</b>
	white = <b>5.....55</b>
	black = <b>6.....66</b>

	switchable = <b>0</b>
	LOXONE AIR dimm = <b>r</b>
	Zigbee dimm = <b>z</b>



# MOVA S L LENS VOLARE

Design: INHOUSE

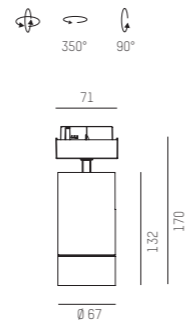

LED Schienenstrahler aus Aluminiumdruckguss.  
Feinstrukturlack in weiß, schwarz oder silber matt.  
Passend für LED Retrofit QPAR 16.  
Exkl. Leuchtmittel.

LED track spotlight made of die-cast aluminium.  
Fine textured paint in white, black or silver matt.  
Suitable for LED Retrofit QPAR 16.  
Without lamps.

Proiettore LED in alluminio pressofuso.  
Verniciatura in bianco, nero oppure grigio opaco.  
Compatibile con lampadine LED Retrofit QPAR16.  
Lampadine escluse.

Projecteur LED en aluminium moulé sous pression.  
Peinture en blanc, noir ou gris mat.  
Compatible avec les ampoules LED QPAR16 Retrofit.  
Sans ampoules.

**VOLARE Schienensystem: Seite 14-17**  
**VOLARE track system: page 14-17**

IP 20

#### MOVA S GU10 VOLARE

1 x QPAR 16- GU10 · 230V · max. 9W Retrofit

495-42000000XX0

Empfohlene Leuchtmittel / recommended bulbs:

QPAR 16- 6,2W · CRI>90 · 2700K · 575lm · 30-675417  
QPAR 16- 6,2W · CRI>90 · 3000K · 575lm · 30-705251



ARTIKELNUMMER ERGÄNZEN / COMPLETE CODE

XX = FARBE/COLOUR

silver matt = 44  
 white = 55  
 black = 66

# MOVA S GU10 VOLARE

Design: INHOUSE





AC - LED Strahler aus Aludruckguss.  
Oberfläche in weiß, schwarz oder silber matt.  
Vakuumbedampfter Alurefektor in 3 Ausstrahlwinkeln.  
Leuchtenkopf 350° drehbar und 90° schwenkbar.

Mains voltage LED spotlight, die cast aluminium.  
White, black or silver matt finish.  
Vacuum deposited aluminium reflector, 3 beam angles.  
Spotlight head 350° swiveling and 90° tilting.

Proiettore a LED a tensione di rete.  
Finitura in bianco, nero o grigio opaco.  
Ottiche in alluminio in 3 fasci di emissione.  
Proiettore girevole a 350°, orientabile a 90°.

Projecteur en LED à tension de réseau.  
Fini en blanc, noir ou gris mat.  
Réflecteur en aluminium en 3 angles d'émission.  
Projecteur tournant à 350°, pivotant à 90°.

W2 = LED 2700K  
W3 = LED 3000K  
W4 = LED 4000K

VOLARE Schienensystem: Seite 14-17  
VOLARE track system: page 14-17

IP 20

#### DASH AC VOLARE

220-240V AC · CRI>90 · Binning SDCM 3 · PASSIVE COOLING

SYS 11W	lm W2	lm W3	lm W4
599-0030101WWXX0	650	690	720
599-0030102WWXX0	650	690	720
599-0030104WWXX0	650	690	720

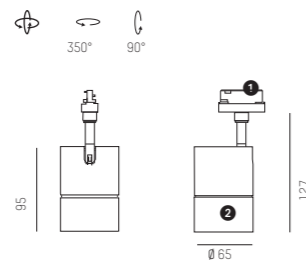

DASH L:  
Dekorring innen standard schwarz  
optional in anderen Farben verfügbar  
Decorative ring inside standard black  
Optional available in other colours

#### DASH L AC VOLARE

220-240V AC · CRI>90 · Binning SDCM 3 · PASSIVE COOLING

SYS 11W	lm W2	lm W3	lm W4
599-0040101WWXX0	650	690	720
599-0040102WWXX0	650	690	720

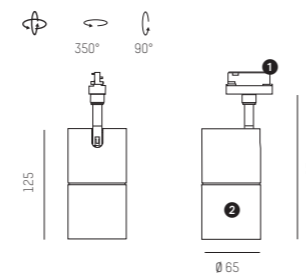

#### DASH L DEKORRING / DECORATIVE RING

innenliegend / inside  
separat ordern / order separately

599-12 599-13 599-15



#### ARTIKELNUMMER ERGÄNZEN / COMPLETE CODE

WW = LICHTFARBE/LIGHT COLOUR

W2	LED 2700K = 23
W3	LED 3000K = 29
W4	LED 4000K = 24

XX = FARBE/COLOUR

	chrome = 1
	silver matt = 4
	white = 5
	black = 6

	chrome = 1 (NOT FOR DASH L)
	silver matt = 4
	white = 5
	black = 6

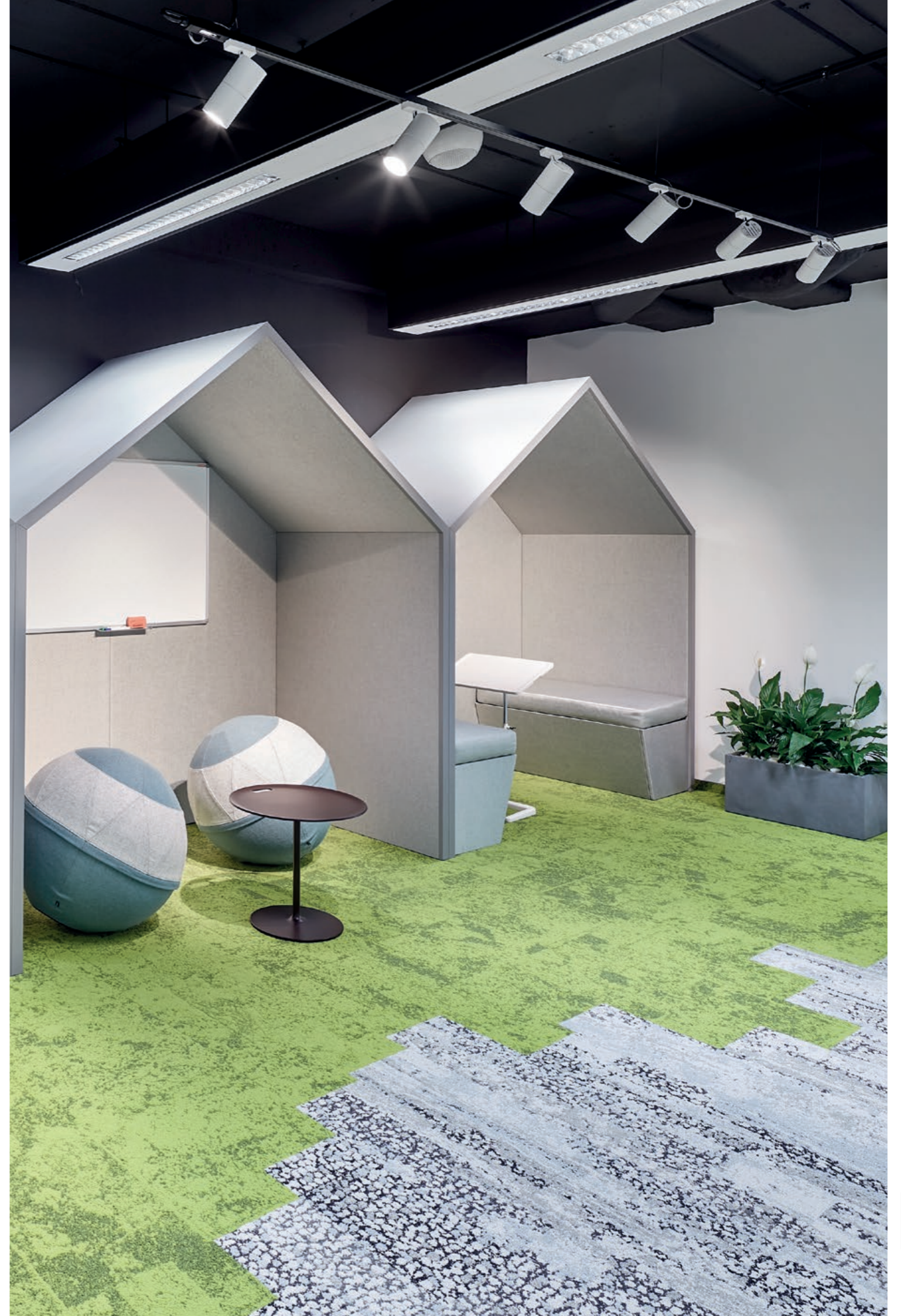



Stromschienenstrahler aus Aludruckguss mit AC-LED. Oberfläche in weiß, schwarz, silber matt oder chrom. Satinierter bündiger Diffusor aus PMMA. Leuchtenkopf 350° drehbar und 90° schwenkbar.

Mains voltage LED track die cast aluminium spotlight. White, black, silver matt or chrome finish. Glossy flush mount PMMA diffuser. Spotlight head 350° swiveling and 90° tilting.

Proiettore a LED a tensione di rete per binario trifase. Finitura in bianco, nero, grigio opaco o cromo. Diffusore satinato rasato in PMMA. Testa proiettore girevole a 350° e inclinabile a 90°.

Projecteur en LED à tension de réseau. Fini en blanc, noir, gris mat ou chrome. Diffuseur satiné ramassé en PMMA. Tête projecteur tournant à 350° et pivotant à 90°.

W2 = LED 2700K  
W3 = LED 3000K  
W4 = LED 4000K

VOLARE Schienensystem: Seite 14-17  
VOLARE track system: page 14-17

IP20

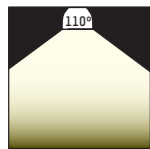

### LITIN AC VOLARE

220-240V AC · CRI >80 · Binning SDCM 3

SYS 10W

651-002021413XX			600lm
651-002021419XX			600lm
651-002021414XX			600lm

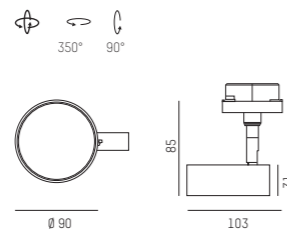

### ARTIKELNUMMER ERGÄNZEN / COMPLETE CODE

XX = FARBE/COLOUR

chrome = 11  
 silver matt = 44  
 white = 55  
 black = 66

### ENTBLENDUNGSRING / NO GLARE DIFFUSER

gerade, mit Bajonettverschluss  
straight, with bayonet cap

651-000014  
651-000015  
651-000016



### ENTBLENDUNGSRING / NO GLARE DIFFUSER

schräg, mit Bajonettverschluss  
angular with bayonet cap

651-000024  
651-000025  
651-000026



Strahlerserie aus Aluminium. Oberfläche eloxiert mit satiniertem Glas. Leuchtenkopf drehbar und schwenkbar.

Spotlight range in aluminium. Anodised surface with satinated glass. Spotlight head swiveling and tilting.

Gamma di faretto in alluminio. Superficie anodizzata. Proiettore girevole ed orientabile.

Gamme de spot en aluminium. Finition anodisée. Projecteur tournant et pivotant.

VOLARE Schienensystem: Seite 14-17  
VOLARE track system: page 14-17

IP20

### MIX VOLARE

1 x QPAR16 · GU10 · 230V · 50W oder/or  
1 x LED RETROFIT · GU10

656-00250000048

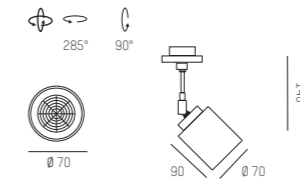

Empfohlene Leuchtmittel / recommended bulbs:

QPAR 16 · 6,2W · CRI >90 · 2700K · 575lm · 30-675417  
QPAR 16 · 6,2W · CRI >90 · 3000K · 575lm · 30-705251





Stromschienenstrahler aus Aluminiumdruckguss.  
Oberfläche in weiß, schwarz oder chrom.  
Ausführung einflammig oder mit zwei Strahlerköpfen.  
Leuchtenkopf 285° drehbar und 90° schwenkbar.

Mains voltage LED track die cast aluminium spotlight.  
White, black or chrome finish.  
Single or double headed.  
Spotlight head 285° swiveling and 90° tilting.

Proiettore a LED a tensione di rete.  
In bianco, nero o cromo.  
Mono o doppia fiamma.  
Testa proiettore girevole a 285° e inclinabile a 90°.

Projecteur en à tension de réseau.  
Superficie en blanc, noir ou chrome.  
Mono ou double spot.  
Tête projecteur tournant à 285° et pivotant à 90°.

**VOLARE Schienensystem: Seite 14-17**  
**VOLARE track system: page 14-17**

IP20

#### SHOOTER 1 VOLARE

1 x QPAR16 · GU10 · 230V · max. 50W oder/or  
1 x LED Retrofit · GU10

**653-002010000XX**

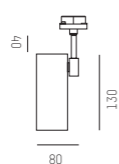

Empfohlene Leuchtmittel / recommended bulbs:

QPAR 16 · 6,2W · CRI>90 · 2700K · 575lm · **30-675417**  
QPAR 16 · 6,2W · CRI>90 · 3000K · 575lm · **30-705251**



#### SHOOTER 2 VOLARE

2 x QPAR16 · GU10 · 230V · max. 50W oder/or  
2 x LED Retrofit · GU10

**653-002020000XX**

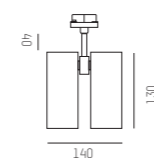

ARTIKELNUMMER ERGÄNZEN / COMPLETE CODE

**XX = FARBE/COLOUR**

chrome = **11**  
 white = **55**  
 black = **66**

Strahlerserie aus Aluminium.  
Oberfläche weiß, schwarz, perlchrom oder chrom.  
Leuchtenkopf 340° drehbar und 90° schwenkbar.

Spotlight range made of aluminium.  
White, black, pearl chrome or chrome.  
Spotlight head 340° swiveling and 90° tilting.

Gamma faretti in alluminio.  
Superficie bianca, nero, cromo satinato o cromo.  
Testa proiettore girevole a 340° e inclinabile a 90°.

Gamme des projecteurs en aluminium.  
Superficie blanc, noir, chrome matt ou chrome.  
Tête projecteur tournant à 340° et pivotant à 90°.

**VOLARE Schienensystem: Seite 14-17**  
**VOLARE track system: page 14-17**

IP20

#### ELLOS VOLARE

1 x QPAR16 · GU10 · 230V · max. 50W oder/or  
1 x LED Retrofit · GU10

**654-002500000XX**

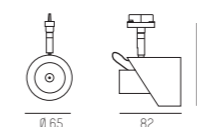

Empfohlene Leuchtmittel / recommended bulbs:

QPAR 16 · 6,2W · CRI>90 · 2700K · 575lm · **30-675417**  
QPAR 16 · 6,2W · CRI>90 · 3000K · 575lm · **30-705251**



ARTIKELNUMMER ERGÄNZEN / COMPLETE CODE

**XX = FARBE/COLOUR**

chrome = **11**  
 pearl chrome = **42**  
 white = **55**  
 black = **66**



Strahlerserie aus Aluminium.  
Oberfläche eloxiert, weiß, schwarz oder chrom.  
285° drehbar und 90° schwenkbar.

Spotlight range made of aluminium.  
Anodised, white, black or chrome.  
Spotlight head swiveling.

Gamma faretti in alluminio.  
Superficie anodizzata, bianca, nero o cromo.  
Testa proiettore girevole.

Gamme des projecteurs en aluminium.  
Superficie anodisée, blanc, noir ou chrome.  
Tête du projecteur pivotant.

**VOLARE Schienensystem: Seite 14-17**  
**VOLARE track system: page 14-17**

IP20

**SENSO VOLARE**

1 x QPAR 16/20 · GU10 · 230V · max. 75W oder/or  
1 x LED Retrofit · GU10

**658-00275000XX**

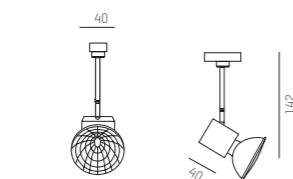

Empfohlene Leuchtmittel / recommended bulbs:

QPAR 16 · 6,2W · CRI>90 · 2700K · 575lm · **30-675417**  
QPAR 16 · 6,2W · CRI>90 · 3000K · 575lm · **30-705251**



**ARTIKELNUMMER ERGÄNZEN / COMPLETE CODE**

**XX = FARBE/COLOUR**

- chrome = 11**
- silver matt = 44**
- white = 55**
- black = 66**



Strahler aus Aluminium.  
Oberfläche weiß, schwarz, perlchrom oder chrom.  
Leuchtenkopf 340° drehbar und 90° schwenkbar.

Spotlight range made of aluminium.  
White, black, pearl chrome or chrome.  
Spotlight head 340° swiveling and 90° tilting.

Gamma faretti in alluminio.  
Superficie bianca, nero, cromo satinato o cromo.  
Testa proiettore girevole a 340° e inclinabile a 90°.

Gamme des projecteurs en aluminium.  
Superficie blanc, noir, chrome matt ou chrome.  
Tête projecteur tournant à 340° et pivotant à 90°.

**VOLARE Schienensystem: Seite 14-17**  
**VOLARE track system: page 14-17**

IP20

**CONTE VOLARE**

1 x QPAR 16/20 · GU10 · 230V · max. 75W oder/or  
1 x LED Retrofit · GU10

**659-00275000XX**

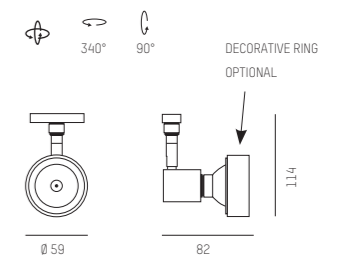

Empfohlene Leuchtmittel / recommended bulbs:

QPAR 16 · 6,2W · CRI>90 · 2700K · 575lm · **30-675417**  
QPAR 16 · 6,2W · CRI>90 · 3000K · 575lm · **30-705251**



**ARTIKELNUMMER ERGÄNZEN / COMPLETE CODE**

**XX = FARBE/COLOUR**

- chrome = 11**
- pearl chrome = 42**
- white = 55**
- black = 66**

**DEKORRING / DECORATIVE RING**

separat ordern / order separately

- 659-000011** für/for QPAR16
- 659-000012** für/for QPAR16
- 659-000015** für/for QPAR16
- 659-000016** für/for QPAR16

- 659-000021** für/for QPAR20
- 659-000022** für/for QPAR20
- 659-000025** für/for QPAR20
- 659-000026** für/for QPAR20

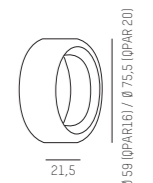

**CONTE VOLARE**

Design: INHOUSE



Stromschienenleuchte aus stranggepresstem Aluprofil.  
Oberfläche weiß oder schwarz pulverbeschichtet.  
LED Konverter im Leuchtenprofil integriert.

Track luminaire, extruded aluminium profile.  
Black or white powder-coated surface.  
With LED converter in profile.

Lampada in alluminio estruso per binario.  
Verniciato a polvere in bianco o nero.  
Converter LED integrato nel profilo estruso.

Luminaire sur rail en aluminium extrudé.  
Laquée blanc ou noir.  
Convertiseur intégré dans le profil.

**W2** = LED 2700K  
**W3** = LED 3000K  
**W4** = LED 4000K

**VOLARE Schienensystem: Seite 14-17**  
**VOLARE track system: page 14-17**

IP 20

#### V-LINE VOLARE

220 - 240V AC · CRI >90 · Binning SDCM 3

SYS 11W	lm <b>W2</b>	lm <b>W3</b>	lm <b>W4</b>
694-11002102 <b>W050</b> <b>W</b>	730	790	820
694-11002102 <b>W060</b> <b>S</b>	670	730	760

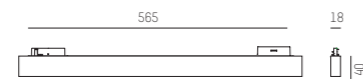

#### V-LINE VOLARE DIMM

**LOXONE Ready**

220 - 240V AC · CRI >90 · Binning SDCM 3

SYS 9W	lm <b>W2</b>	lm <b>W3</b>	lm <b>W4</b>
694-11001102 <b>W05Y</b> <b>W</b>	580	630	660
694-11001102 <b>W06Y</b> <b>S</b>	540	580	610

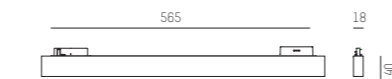

#### ARTIKELNUMMER ERGÄNZEN / COMPLETE CODE

**W** = LICHTFARBE/LIGHT COLOUR

**W2** LED 2700K = 3  
**W3** LED 3000K = 9  
**W4** LED 4000K = 4

**Y** = DIMMBAR / DIMMABLE

**L** LOXONE AIR dimm = r  
**Z** Zigbee dimm = z

